



INTRODUCING

the LittleOnes™

**USAI**®  
Lighting

Hello,  
Tiny!

Actual Size



1"



## Meet the LittleOnes

Who says **TINY** comes at the expense of performance? **USAI Lighting** is defying the norm and what is possible as we raise the bar in design and engineering with a new one-inch recessed fixture family that will knock your socks off.

# Two to

# Love

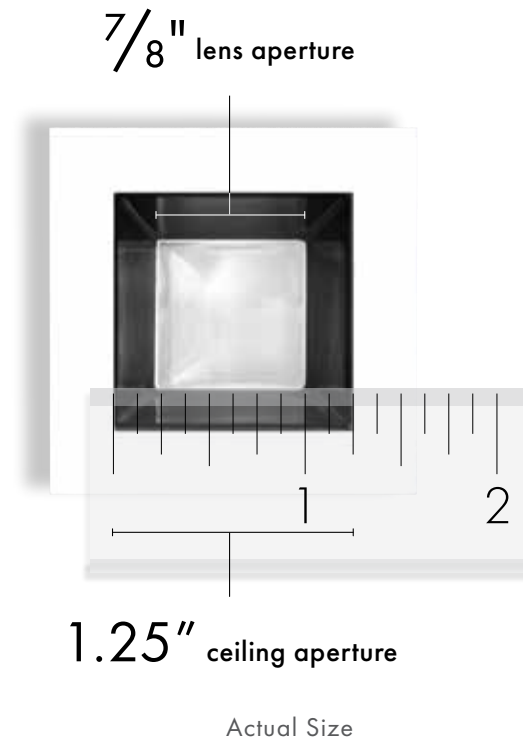

**LittleOnes Micro** is the USAI BeveLED family's newest tiny member.

Unique for its outstanding flexibility with a full family offering, this 1.25" dynamo provides the ultimate versatility possible in an LED fixture this small.

It's installable AND serviceable from below, and its square or round shapes can work with most typical ceiling types, including retrofit applications.

**Have you ever met a tiny ONE like this?**

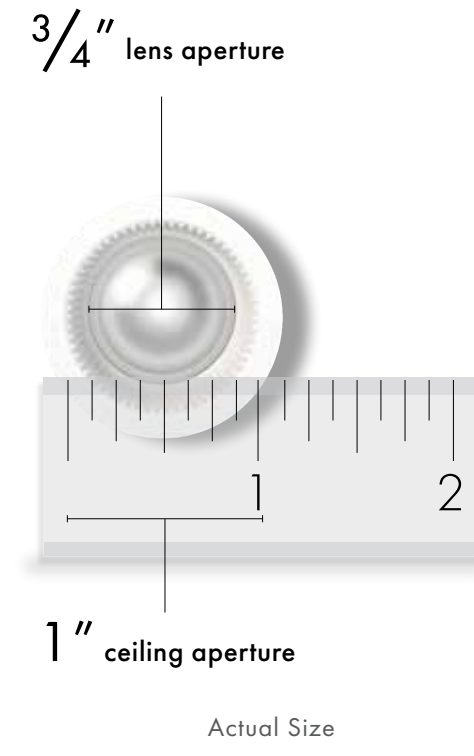

Defying what we thought possible and exceeding expectations.

**Don't be fooled by its 1" size and lens aperture of  $3/4$ !"**

Yes, this guy is TINY. Like its metric system namesake, **it's teeny tiny and POWERFUL.** This little guy packs a stealth punch with up to 1100 delivered lumens and literally off-the-charts glare control. Zepto provides unparalleled performance with an ultra discreet trim aesthetic.

the LittleOnes™ **Micro**

the LittleOnes™ **Zepto™**

# The Power of Tiny

The best light sources reveal spaces, not themselves. USAI LittleOne's full lighting platform reaches new heights with a 1" aperture that's so little, it feels invisible, yet beams brilliance and creativity with high-performance.



Downlight



Wall Wash



Adjustable

## the LittleOnes **MICRO 1.25"**

**THE POWER** – Up to **800** Delivered Lumens

**LITTLE** – 1.25" Aperture

**SHAPE** – Round and Square

**BEVELED BEAUTY** – Beveled Profile Trim Option to Match USAI's Iconic and Extensive BeveLED Family

**TRIM OPTIONS** – Trimmed, Trimless, Millwork

**EASE** – Install from Below Options, Always Serviceable from Below

**HOUSING** – New Construction, IC-rated, CP Rated, and Retrofit Housing Options

**WATTAGE** – 7W & 9W

**OUTSTANDING GLARE CONTROL** – UGR Less than One. Not Measurable.

**BEAM SPREADS** – 25°, 35° and 50°

 Classic White® 2700K | 3000K | 3500K | 4000K

**FINISH OPTIONS**



Matte White



Matte Black



Specular Black

# ...Everything You Need to Light A Space



Downlight



Wall Wash

## the LittleOnes **ZEPTO 1"**

**THE POWER** - Up to **1100** Delivered Lumens

**LITTLE** – 1" Aperture

**SHAPE** – Round

**DISCREET BEAUTY** – Minimal Appearance

**TRIM OPTIONS** – Microflange and Trimless

**EASE** – Always Serviceable from Below

**HOUSING** - New Construction, IC-rated, and Integral Driver housing options

**WATTAGE** - 7W, 9W, 11W, 15W

**OUTSTANDING GLARE CONTROL** – UGR Less than One. Not Measurable.

**BEAM SPREADS** – 35° and 45°

 Classic White™ 2700K | 3000K | 3500K | 4000K

**FINISH OPTIONS**



Matte White



Matte Black



Specular Black



JA8 Qualified



Dry, Damp, Wet Locations



Meets WELL Building Standards

**IC**  
RATED  
OPTIONS

**CP**  
RATED  
OPTIONS



IBEW Union Made

  
0.1% Dimming  
Options

**5**  
YEAR  
WARRANTY

---

**Lives  
anywhere**  
& works with  
**any  
ceiling  
type**

---

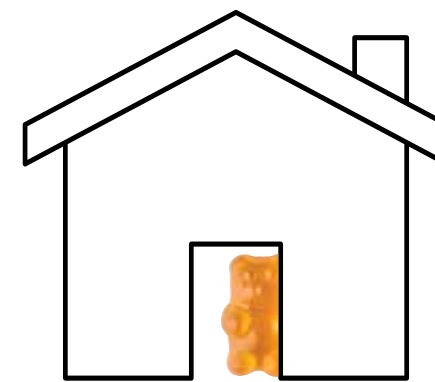

the LittleOnes™









**SMALL SPACES** | Perfectly Proportioned



**RESTAURANTS** | Comfort Lighting



**HOSPITALITY** | Create Patterns with LittleOnes Micro Doubles

---

**Optics**  
like you've  
never seen  
before

---



the LittleOnes™





# Seeing is Believing

Imagine the unexpected.

What would outstanding optical performance in a **tiny 1" aperture** look like? USAI's proprietary 5-part optical system delivers a perfect wall wash from the ceiling to the floor.

## ENGINEERED FOR PERFECTION

**1** Excellent Light Uniformity

Beautiful, smooth light illuminates the entire wall from ceiling to floor without shadows.

**2** Precise Beam Control

Engineered to concentrate, spread and direct light in all the right places.

**3** Ultra Low Glare

Perfectly comfortable from every angle with no back light.

**4** Best In Class Beam Quality

A truly exceptional and first of its kind wall wash optical system in a tiny package.

# Optics Reimagined

The LittleOnes produce an excellent wall wash distribution for evenly lit walls from floor to ceiling - with no scalloping, shadows or backlight.

Performance once only available in larger fixtures now possible in a 1" aperture.

	• 14	• 14	• 14	• 14	• 14	• 14	• 14	• 14	• 14	• 14
1ft	• 20	• 20	• 20	• 20	• 20	• 20	• 20	• 20	• 20	• 20
2ft	• 27	• 27	• 27	• 27	• 27	• 27	• 27	• 27	• 27	• 27
3ft	• 24	• 24	• 24	• 24	• 24	• 24	• 24	• 24	• 24	• 24
4ft	• 18	• 20	• 18	• 20	• 18	• 20	• 18	• 20	• 18	• 20
5ft	• 14	• 14	• 14	• 14	• 14	• 14	• 14	• 14	• 14	• 14
6ft	• 9	• 11	• 9	• 11	• 9	• 11	• 9	• 11	• 9	• 11
7ft	• 8	• 8	• 8	• 8	• 8	• 8	• 8	• 8	• 8	• 8
8ft	• 6	• 6	• 6	• 6	• 6	• 6	• 6	• 6	• 6	• 6
9ft	• 6	• 6	• 6	• 6	• 6	• 6	• 6	• 6	• 6	• 6

## Perfect Wall Wash Lights Smoothly from Ceiling to Floor

Measurements taken using an 18" on center spacing and 24" wall offset

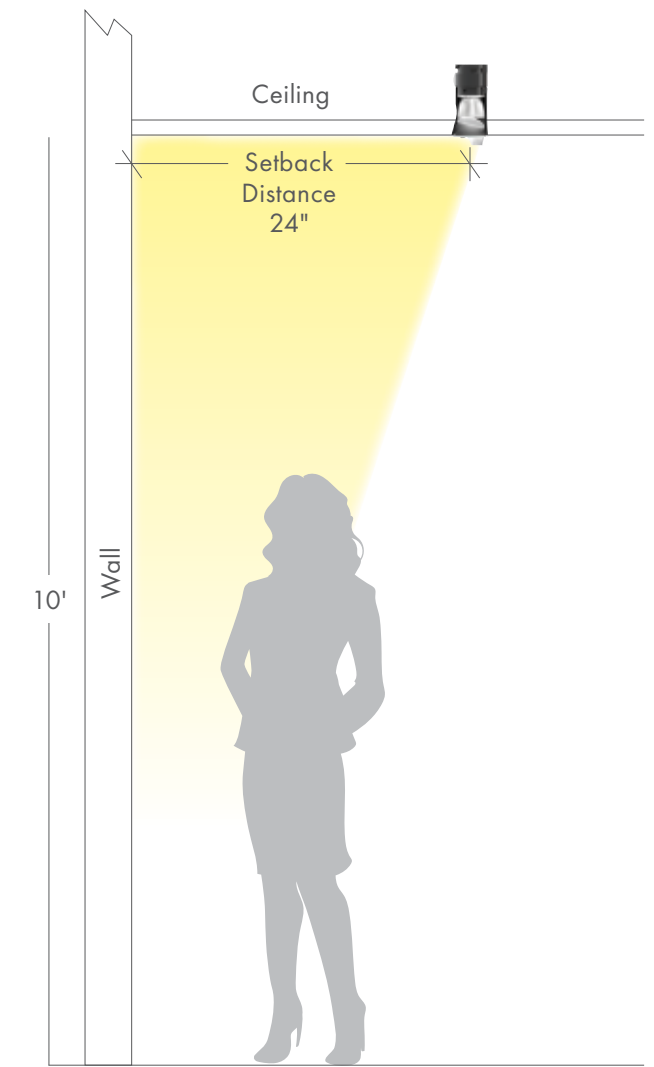

## All in the Engineering

- Exceptional **4.5 : 1** Vertical Uniformity Ratio.
- USAI's patented **5-part optical system** delivers even light all the way to the ceiling line.

# Quiet, Tiny and Powerful

LittleOnes Micro makes it possible to light ceilings with smaller and more efficient light fixtures.



## the LittleOnes Micro Optics

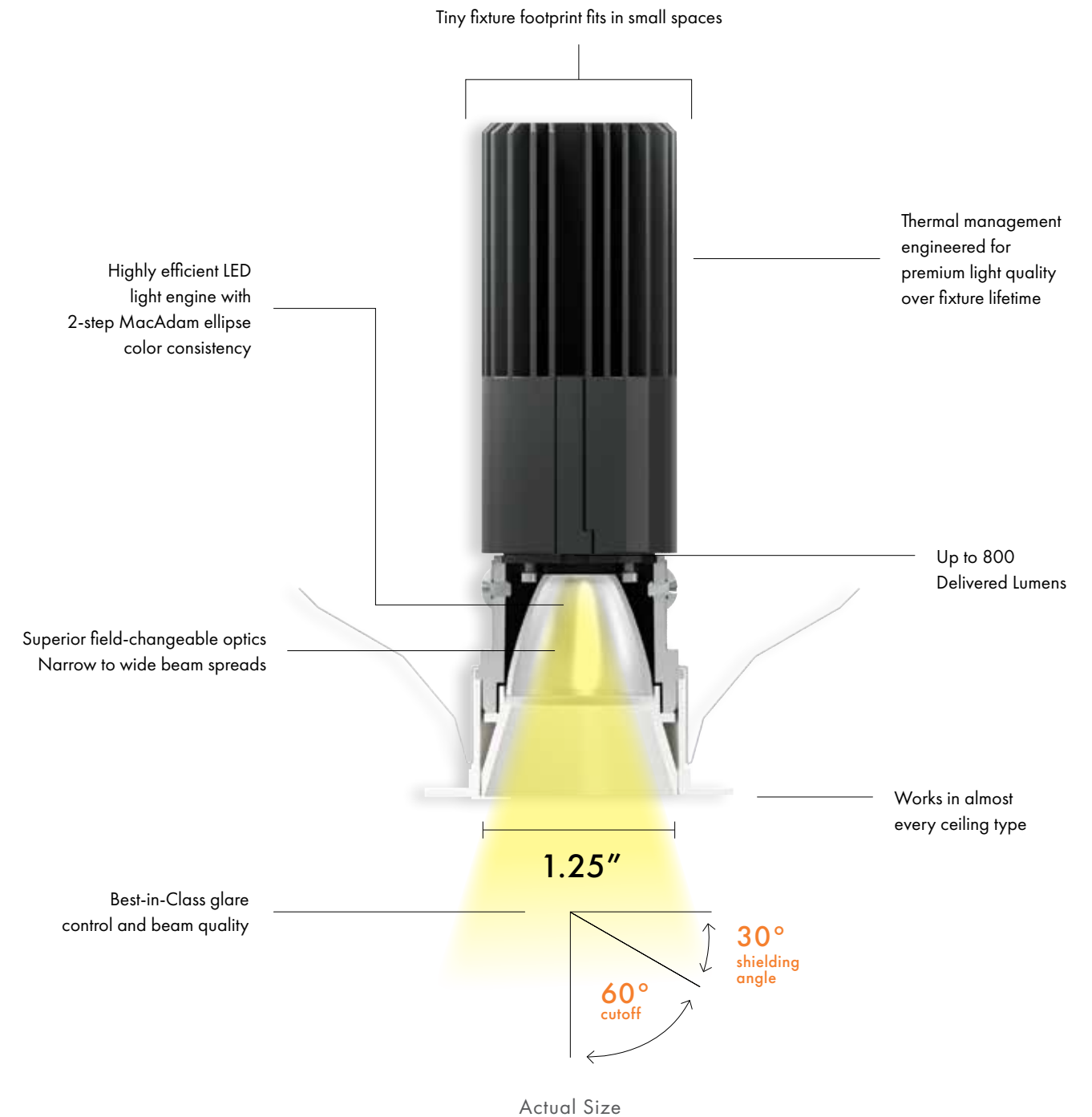

## Designing for the Details with Micro

Application efficiency and light where you want it - delivered in full. These tiny points of light deliver up to 800 lumens for the perfect, comfortable illumination in any project. Hex louver trims are also available to compliment the already comfortable, precision designed, low glare optics.

# Double Duty for Busy Spaces

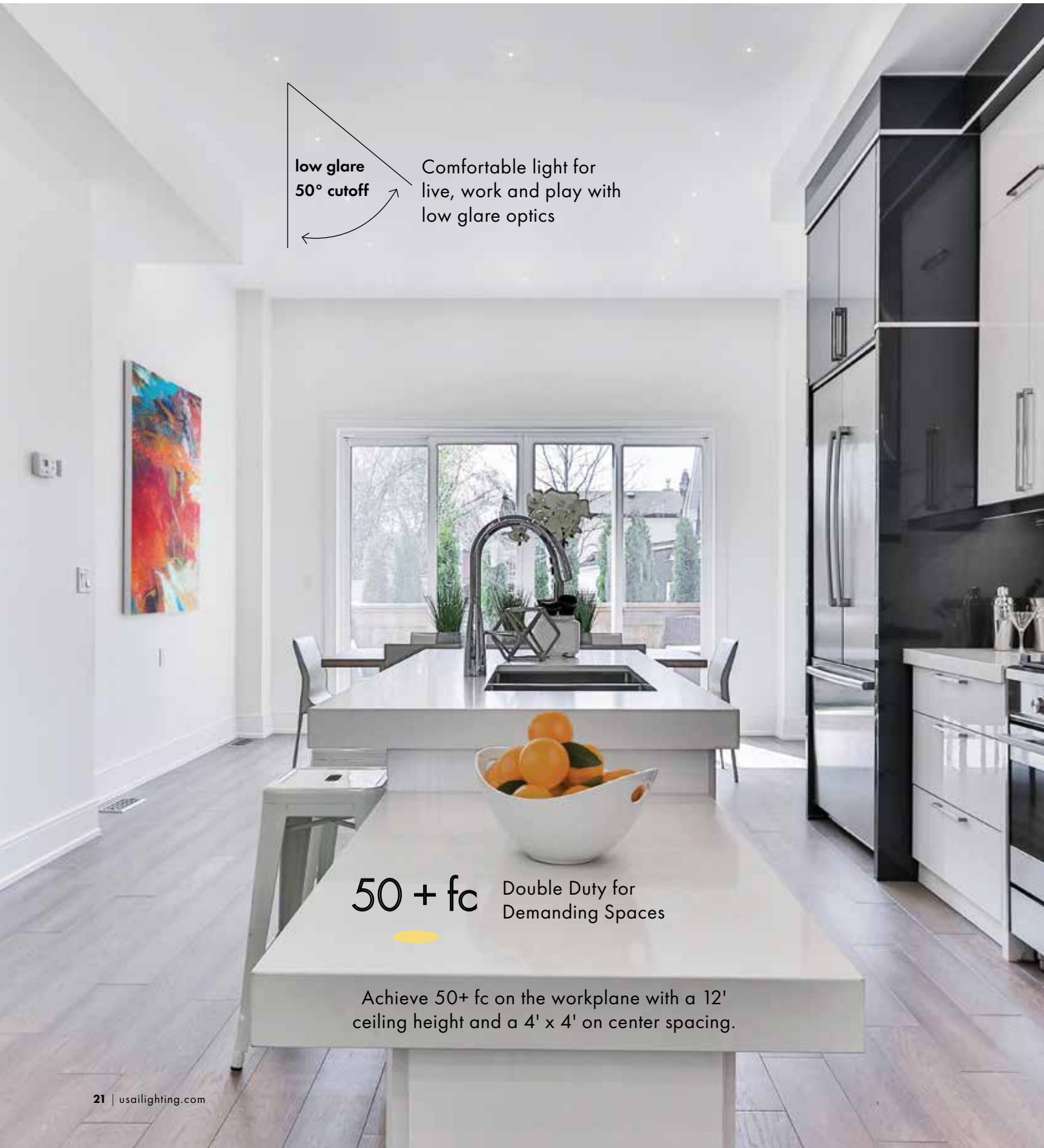

## the LittleOnes Zepto Optics

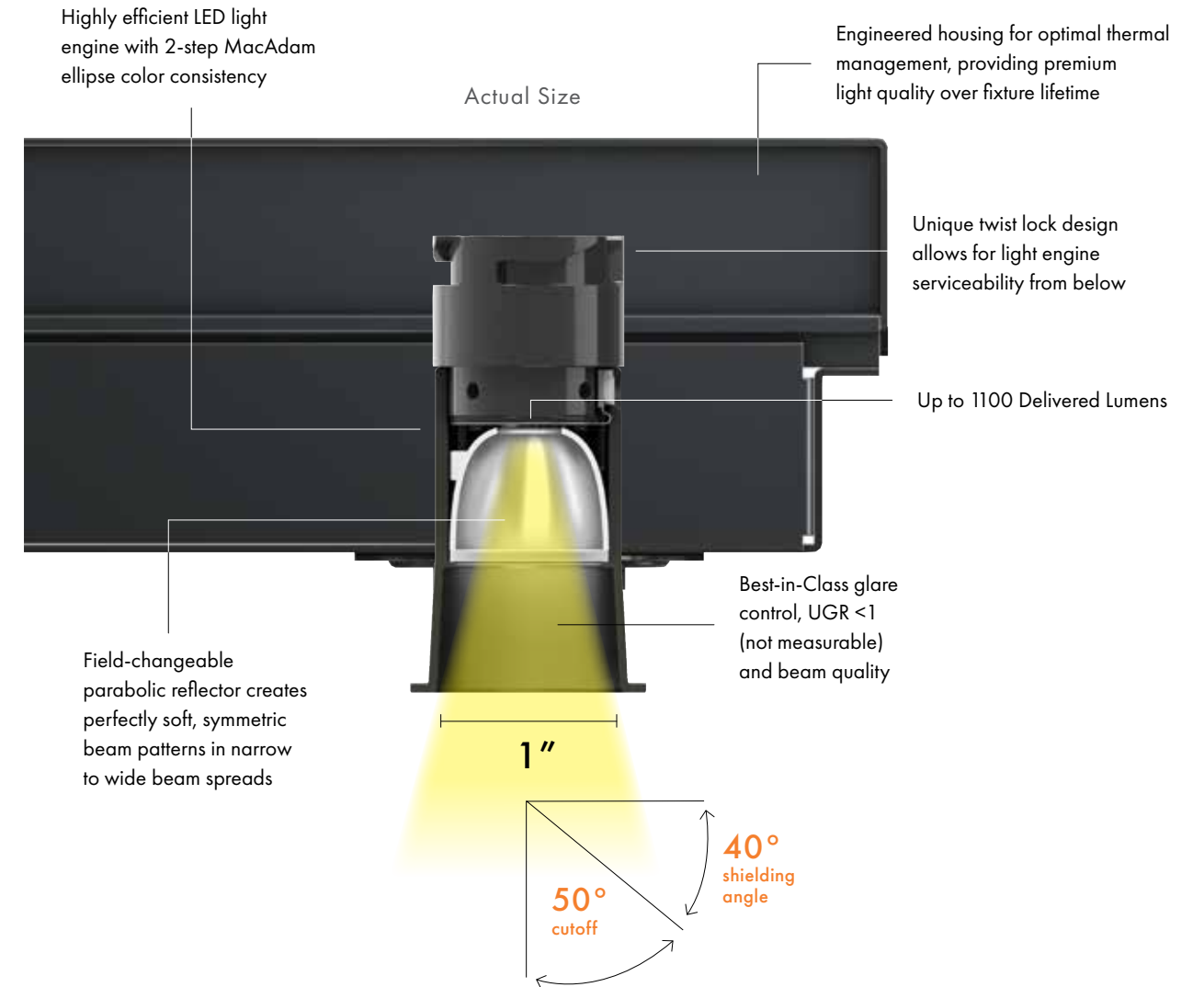

## Power and Comfort Together with Zepto

the LittleOnes Zepto delivers an incredible punch from a miniscule aperture to illuminate any type of space, all while keeping ceilings quiet and comfort maximized with such amazing glare control that its glare level is not even measurable! Delivering up to 1100 lumens, this LittleOne easily provides the light you need for the most demanding of tasks and applications.



---

# Solutions

for every  
installation

---

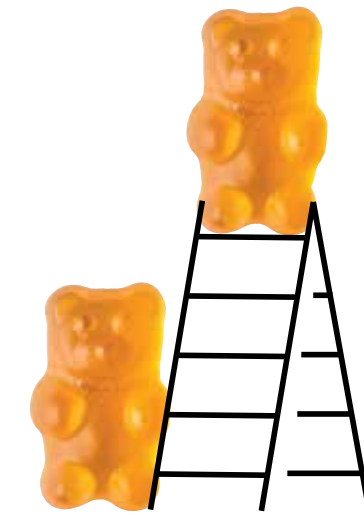

the LittleOnes™

# the LittleOnes Micro Install & Service from Below

During renovations and projects with existing ceilings, simplicity is key. Why remove an entire ceiling when you don't have to? With the LittleOnes Micro 1.25" flanged fixtures, installation from below is simple. A tiny, beautiful, and serviceable light fixture is only three steps away.



**1 CUT**  
Cut ceiling opening in drywall, wood, metal, or robust acoustical material with commonly available drillbit (for round) or saw (for square)

**2 CONNECT**  
Connect trim to remote driver with a simple quick connector

**3 INSERT**  
Squeeze spring clips together, and push LittleOnes Micro flanged trim into ceiling opening until the flange meets the surface

## Install and Service from Below.

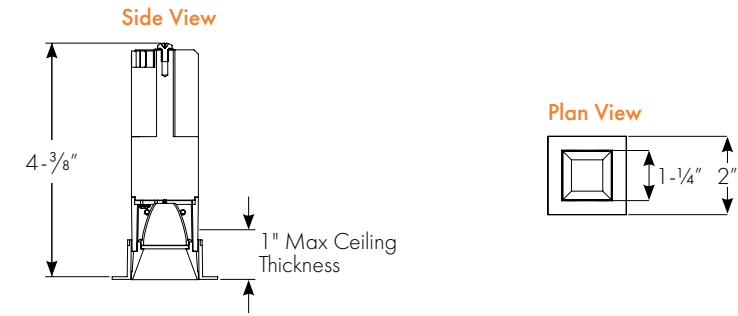

### Retrofit (RT) (Flanged Only)\*

### Retrofit (Flanged Only)

the LittleOnes Micro 1.25" can be installed in existing ceilings for retrofit applications. Simply cut a hole in existing drywall or wood ceilings to install the flanged trim.

## Install from Above. Service from Below.

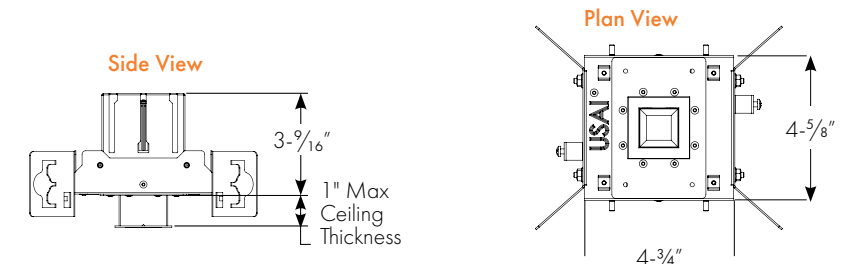

### New Construction (NC)\* Rough-In

(required for Trimless, Millwork, and ACT ceiling installations)

### New Construction Rough-In

A rough-in housing option is available for all new construction projects and a variety of ceiling types, including acoustical ceilings

## Install from Above. Service from Below.

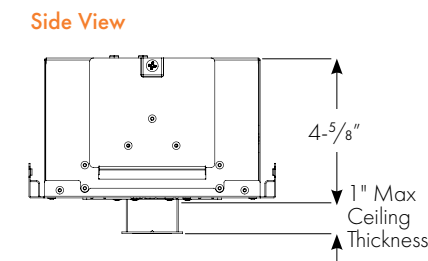
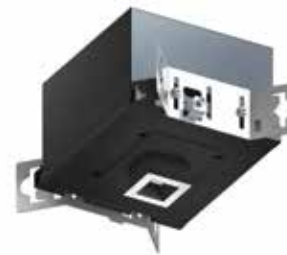

### Insulation Contact (IC)\* Chicago Plenum (CP)\*

 Title 24 JA8 Compliant versions available

\*Remote power supplies required for all LittleOnes Micro fixtures

### Insulation Contact

An IC-Rated housing allows placement of the LittleOnes Micro 1.25" in direct contact with insulation, whether a flanged, trimless, or millwork aesthetic is desired.

### Chicago Plenum

Our CP-rated rough-in housing satisfies Chicago's plenum requirements.

# the LittleOnes Zepto Service from Below

Zepto's proprietary, patented design makes the impossible possible – allowing LittleOnes Zepto to illuminate with 15W of sheer power AND serviceable from below through a 3/4" aperture. the LittleOnes Zepto LED light engine and optics can be accessed and swapped out from below the ceiling plane in 3 easy steps, without any mess or disruption to the ceiling.



**1 PULL**  
Pull down on LittleOnes Zepto trim using your thumb to remove trim.

**2 TWIST**  
Insert servicing tool to key into optics and light engine, twist counter-clockwise, then pull to remove from housing

**3 SWAP**  
Disconnect power, and quick connection wiring. Replace light engine and optic.

## Service from Below.



### New Construction Housing (NC)\*

\*For use with remote power supply only

Side View

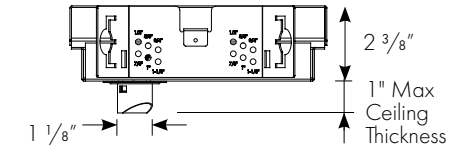

Plan View

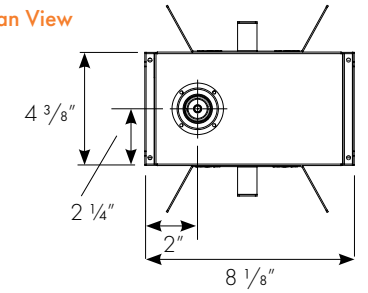

### New Construction Rough-In

A rough-in housing option is required for all Zepto installations.

## Service from Above.



### New Construction Sidecar Housing with Integral Driver (NCSC)\*\*

\*\*Above ceiling access required for all integral driver housing installations

Side View

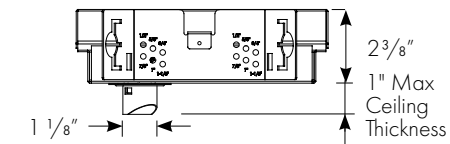

Plan View

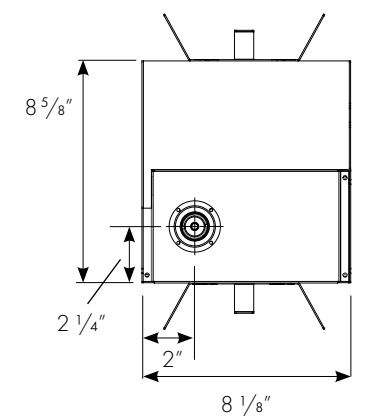

### Integral Driver Housing

The LittleOnes Zepto 1" is available with a new construction sidecar housing that includes the dimming driver for convenience in accessible ceilings.

## Service from Below.



### Insulation Contact (IC)\*

\*For use with remote power supply only

### Insulation Contact

An IC-Rated housing allows placement of the LittleOnes Zepto 1" in direct contact with insulation.

Title 24 JA8 Compliant versions available

For **1** 9W or 15W and **2+** 7W LED options

Side View

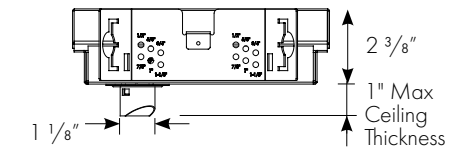

For **2+** 11W LED option

Side View

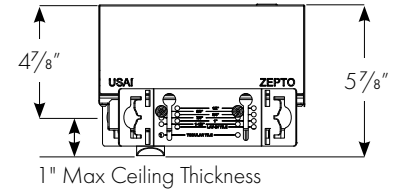

Plan View

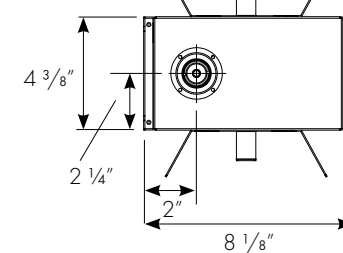

Plan View

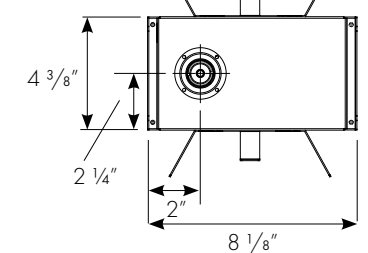

# Installation Made Easy with Remote Drivers

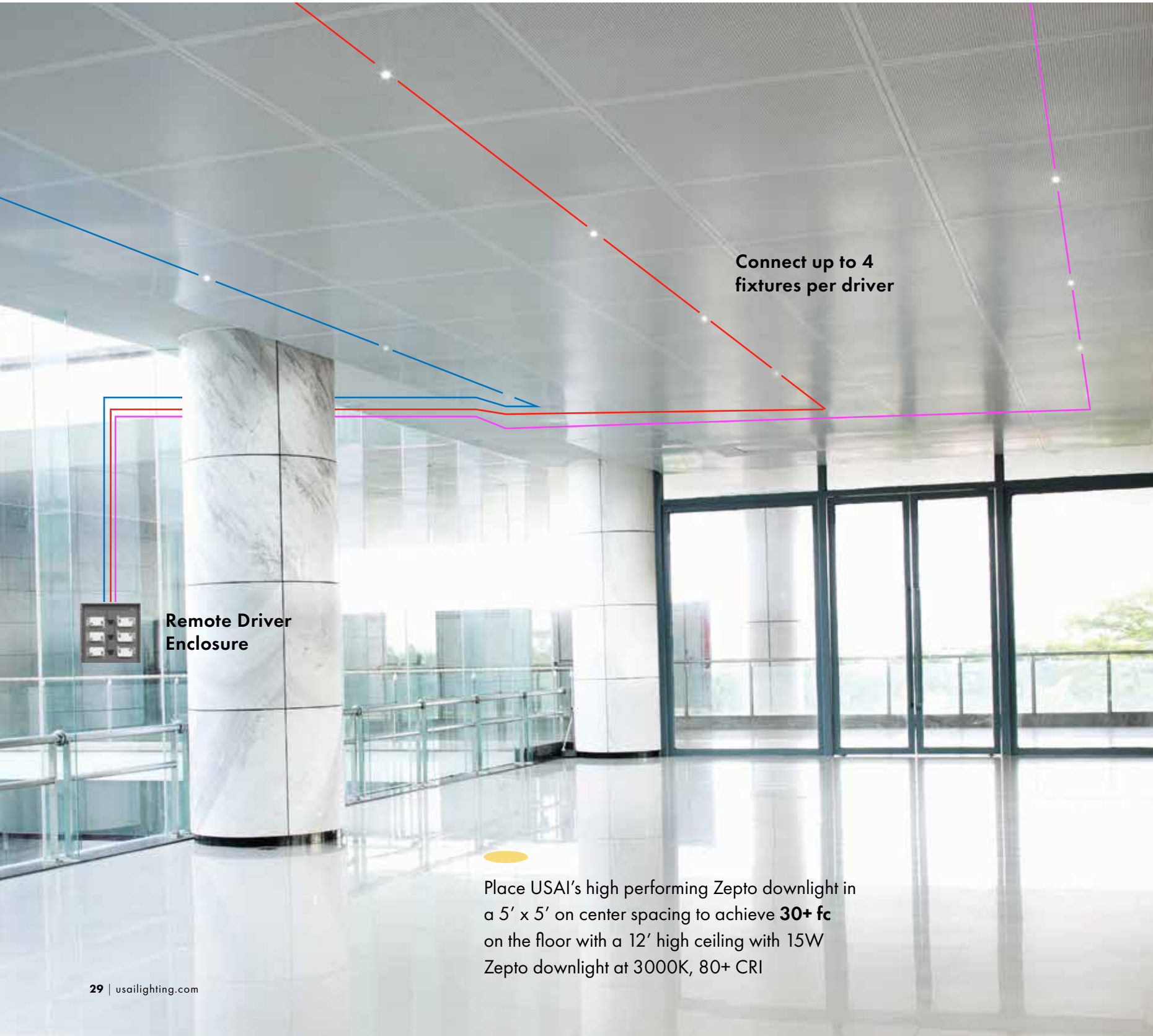

Place USAI's high performing Zepto downlight in a 5' x 5' on center spacing to achieve **30+ fc** on the floor with a 12' high ceiling with 15W Zepto downlight at 3000K, 80+ CRI

## 2 Ways to Work Remote

### High Output with 1 Fixture Per Driver

Dedicating one fixture per driver provides optimal performance and best possible delivered light output



### Standard Output with 2+ Multiple Fixtures Per Driver

Connect up to four light fixtures at a time to one dimming driver for efficient power distribution and cost savings.

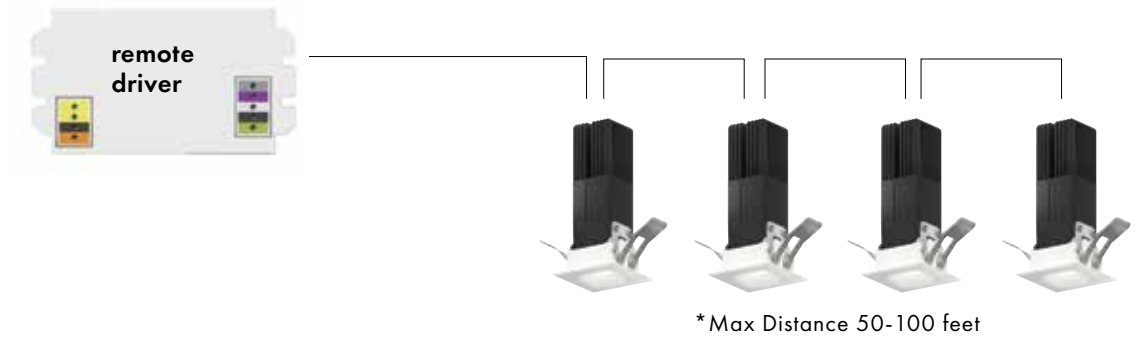

## Multiple Dimming Choices

USAI's LittleOnes are compatible with all common lighting controls; choose from 0-10V, Phase, EcoSystem, DMX, or DALI dimming

## Optional USAI Enclosures



**6 Driver Prewired Enclosure**  
Can power up to 24 LittleOnes fixtures



Contact a USAI sales representative for applications support to configure and specify enclosures for your project.

**12 Driver Prewired Enclosure**  
Can power up to 48 LittleOnes fixtures



---

**All in the  
family  
consistent roomside  
appearance**

---

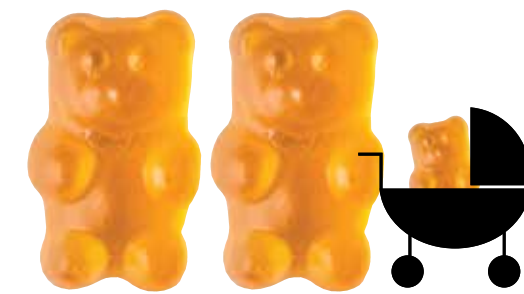

the LittleOnes™

# Tiny Meets Small

Meet all of your LED downlight needs at USAI Lighting. Each product has its own set of capabilities with a full family of offerings. Choose from a complete platform of high-performance light fixtures to address every design requirement with the greatest flexibility from space-to-space.

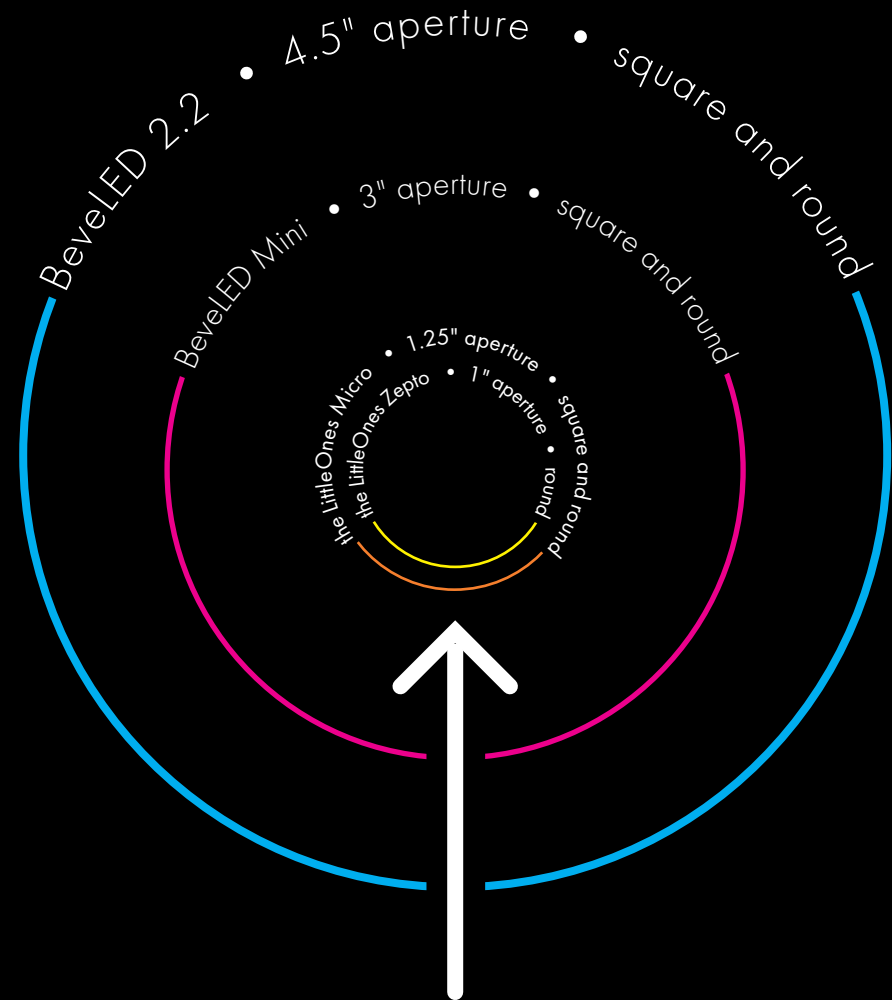

**A Size for Every Space**



**Square + Round**

**1"**



LittleOnes **Zepto** 1"



LittleOnes **Micro** 1.25"

**3"**



BeveLED Mini®

**4.5"**



BeveLED® 2.2

# All in the Family

USA Lighting believes in the power of innovating for small whether it's housings, recessed downlights or surface mounts and pendants. Mix and match to suit your design needs.



## SHALLOW HOUSINGS



BabyLED®  
3"  
aperture

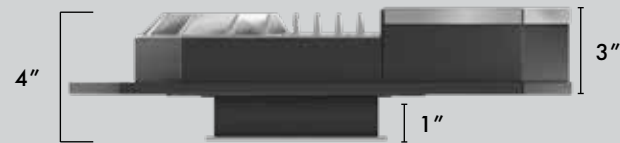

BeveLED® Flat FT  
4.5"  
aperture

## SMALL RECESSED DOWNLIGHTS



LittleOnes Zepto  
1"



LittleOnes Micro  
1.25"



Micro  
1.25" cells



SliverLED®  
1.75"



BeveLED Mini®  
3"

## SMALL SURFACE MOUNTED + PENDANTS

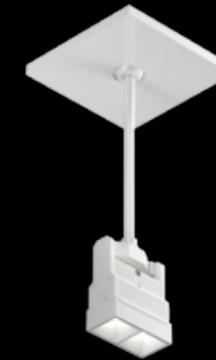

Micro Pendant  
1.25" cells



NanoLED® Glow  
Cylinder  
3"



NanoLED®  
Cylinder  
3"

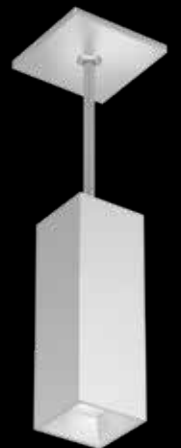

BeveLED Mini®  
Cylinder  
3.5"

# Which LittleOne is right for your space?

Lighting That Checks Every Box

	LittleOnes Micro	LittleOnes Zepto
<b>TRIM</b>		
Ceiling Aperture	1.25"	1"
Optical Aperture	.787"	0.75"
Round	✓	✓
Square	✓	
Trimmed	✓	✓ Microflange
Trimless	✓	✓
Millwork	✓	
<b>HOUSINGS</b>		
Rough in Housing	✓	✓ Required
For Shallow Plenum	✓	✓
IC Housing	✓	✓
CP Housing	✓	
Wet Location	✓	✓
<b>PHOTOMETRICS</b>		
Source Lumens*	800 - 1000lm	800 - 1475lm
Delivered Lumens*	375 - 800lm	275 - 1100lm
Wattage	7W, 9W	7W, 9W, 11W, 15W
Downlight	25°, 35°, 50°	35°, 45°
Adjustable	25°, 35°, 50°	
Wall Wash	✓	✓
Cutoff Angle (Downlight)	60°	50°
<b>INSTALLATION</b>		
Serviceable from Below	✓	✓
Install from Below	✓ Trimmed only	
Remote Drivers	✓	✓
Integral Driver Option		✓
USAI Enclosures for Remote Drivers	✓	✓

\*Max Lumens at 3000K, 80+ CRI

# FAQs

**Q: Do the LittleOnes always require remote drivers? Where is the ideal location for remote drivers and how far away can I position them?**

**A:** Due to the LittleOnes' miniscule size and tiny 1" apertures, it is not possible to access dimming drivers for service from below the ceiling. All of the LittleOnes are available with remote drivers which can easily be accessed in service panels or electrical closets, and they can be located up to 100 ft away depending on wire gauge used. We do have one housing option with Zepto that can house an integral driver, but this fixture would require above ceiling access to remove that driver from the housing for service.

**Q: Which control systems are compatible with the LittleOnes?**

**A:** As with all USAI Lighting products, the LittleOnes are compatible with every major architectural control system you could choose to use, including 0 - 10V low voltage dimming, line voltage phase dimming, and digital dimming protocols such as DMX, DALI, and Lutron EcoSystem.

**Q: How well will the LittleOnes light my walls? How close do they need to be?**

**A:** Despite their tiny size, the LittleOnes are outstanding in wall wash applications, providing perfect uniformity from floor to ceiling. For best results, we recommend placing them 24" from the wall and no more than 18" apart from each other.

**Q: Can I place the LittleOnes in wet locations such as showers and outdoor covered spaces?**

**A:** Yes! All of the LittleOnes are UL dry/damp/wet location rated.

**Q: Can I service the LittleOnes LED and optics from below?**

**A:** Yes! If a change is desired in LED color or optics and beam spread, you may need to access internal components. USAI's engineering has made this access easy and painless.

**Q: How far apart can I space the LittleOnes and still light evenly?**

**A:** Even though they're only 1" in size, we have found that the LittleOnes can be placed up to 4', 5', and 6' apart while still delivering useful light and great uniformity. If you're not sure, you can always contact USAI for help with applications calculations for your project.

**Q: What is the maximum ceiling height recommended for the LittleOnes?**

**A:** The answer to this question depends on how much light you need, and how closely you are placing the LittleOnes to each other. We have found that the LittleOnes can provide beautiful illumination in 8', 10', and 12' ceilings. When ceiling heights get to 14' and higher, consider using other USAI products with larger apertures and more light output; we offer a full family of companion products for the LittleOnes with similar trim aesthetics - so they look great together.

**Q: How do I use the LittleOnes as emergency fixtures?**

**A:** The LittleOnes can be specified with a remote emergency power module. Simply use the One Fixture per Driver ordering tables to specify the LittleOnes light fixture of your choice, and then specify a remote dimming driver with the EM option. All remote dimming drivers with the EM option require a remote enclosure. Two or more fixture per driver options can be used as emergency fixtures with the use of inverters. See spec sheets for details.

**Q: When should I use the install from below option vs install from above?**

**A:** The LittleOnes family is designed to be as flexible as possible for all installation types. The install from below option of the LittleOnes Micro downlight can be utilized when installing in a sheetrock ceiling that is already in place. If installing in ACT, Millwork, or for a spackled in trimless aesthetic the LittleOnes offer install from above options.

**Q: In what ceiling types do the LittleOnes work?**

**A:** The LittleOnes family works in almost every type of ceiling imaginable, including but not limited to: sheetrock, plaster, wood, tile, acoustical tiles, metal panels, and more. The LittleOnes also offers IC-rated and CP-rated housing options to meet specific construction requirements.





# Let's play

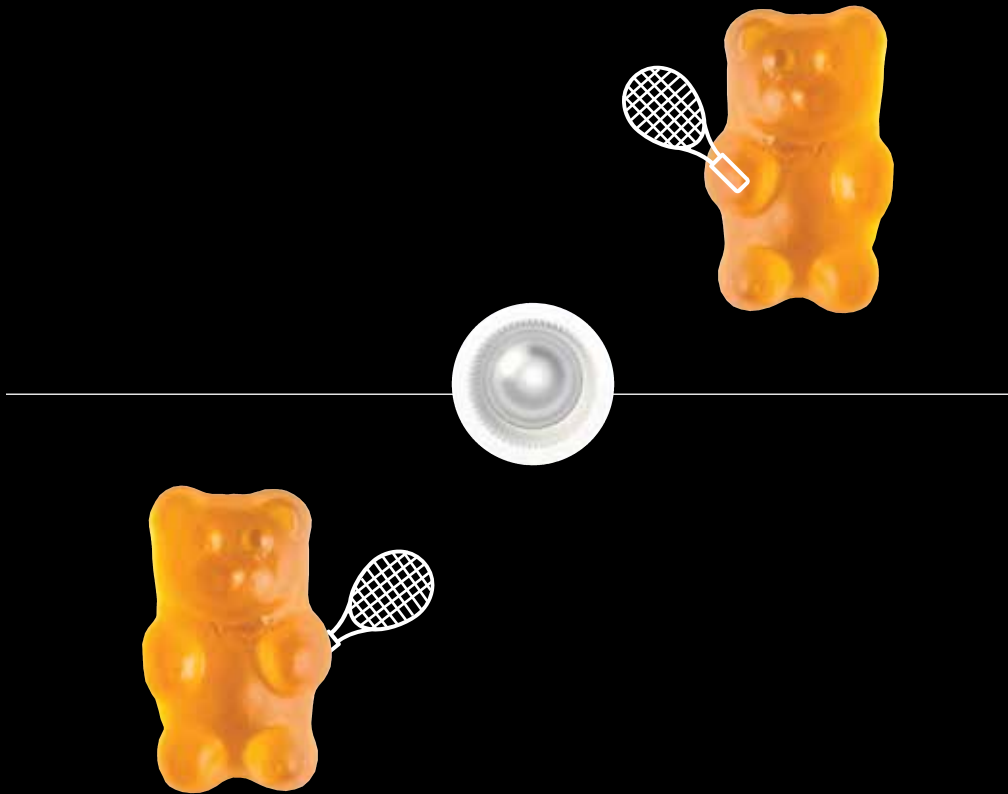

**USAI**<sup>®</sup>  
Lighting

CALL, EMAIL, OR VISIT [USAILIGHTING.COM](http://USAILIGHTING.COM) TO LEARN MORE

**USAI LIGHTING COLLABORATORY**

13 CROSBY STREET  
NEW YORK, NY 10013  
(845) 234-4090  
[SHOWROOM@USAILIGHTING.COM](mailto:SHOWROOM@USAILIGHTING.COM)

**USAI LIGHTING HEADQUARTERS**

1126 RIVER ROAD  
NEW WINDSOR, NY 12553  
(845) 565-8500  
[INFO@USAILIGHTING.COM](mailto:INFO@USAILIGHTING.COM)

© 2022 USAI Lighting.  
All rights reserved. the LittleOnes, the LittleOnes Micro, the LittleOnes Zepto are trademarked, and USAI, BabyLED, BeveLED, BeveLED Mini, SliverLED, NanoLED and Classic White are registered trademarks of USAI, LLC. All designs protected by copyright. Patents pending. CA-103A