

USAI® Lighting

# the LittleOnes® Micro Doubles

APPLICATION GUIDE





# DOUBLE THE POWER

with the LittleOnes<sup>®</sup> Micro Doubles

This LittleOnes Micro Doubles application guide provides useful technical information on how to best leverage USAI Lighting's new collection of LittleOnes in pairs in your next project.

## CONTENTS

Full Family Platform 03

Double Downlight 05

Double Wall Wash 11

Mix and Match 15

Double Adjustable 23

Turn Key Solutions 33

Optical Features 35

Housing Options 37

Driver Choices 39

Related Products  
FAQs 41

# the LittleOnes<sup>®</sup> Micro Doubles

## FULL FAMILY

### HIGH PERFORMANCE FEATURES AND SPECIFICATIONS

**THE POWER**

Up to 1600 Delivered Lumens (800 lms per head)

**LITTLE**

1-1/4" Aperture

**SHAPE**

Round and Square

**CONSISTENT AESTHETIC**

Perfect Match to the LittleOnes Micro and Micro Multi-Cell

**TRIM OPTIONS**

Trimmed, Trimless

**HOUSING**

Integral and Remote Driver Housing Option for New Construction

**WATTAGE**

14W-18W

**BEAM SPREADS**

25°, 35° and 50° + Wall Wash

**LENSES AND ACCESSORIES**

Linear Spread Lens, Color Shifting (CTO) Filters, Hexcell Louver



**Classic White<sup>®</sup>**

2700K, 3000K, 3500K, 4000K, 80+ and 90+ CRI



**Dim-To-Warm +**

3000K - 2000K, 90+ CRI

**DRIVER CHOICES**

Choose between efficiency with one remote driver per fixture and flexibility with one driver per head.

**FINISH OPTIONS**

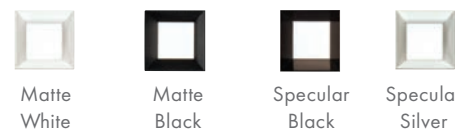

Matte White

Matte Black

Specular Black

Specular Silver



LBC Red List Approved



IBEW Union Made



Meets WELL Building Standards



0.1% Dimming Options



Dry, Damp, Wet Locations



5 Year Warranty



Buy American Act Compliant



NRTL/CSA-US Listed

### THE LITTLEONES MICRO DOUBLES COMBINATIONS

Available in trimmed and trimless, round and square, with black and white finishes, there's an option for nearly every design intent. Choose combination finishes of black bevels with white flanges for visually quiet ceiling integrations.

	Trimless White	Trimless Black	Trimmed White Bevel	Trimmed Black Bevel
Double Downlight Round				
Double Downlight Square				
Double Adjustable Round				
Double Adjustable Square				
Double Wall Wash Round				
Double Wall Wash Square				
*One Downlight & One Wall Wash Round				
*One Downlight & One Wall Wash Square				

\*Mix and match your own by combining one downlight head with one wall wash head.

# DOUBLE DOWNLIGHT

Ideal for General Ambient Illumination



- Design Features Include**
- Fixture head spacing consistent, and as close as possible
  - Prepackaged design for easier installation
  - Double the lumen output of the LittleOnes Micro

## BEST IN CLASS DOWNLIGHTS WITH SUPERIOR GLARE CONTROL

**UP TO 1600 LUMENS**

**HIGH PERFORMANCE**  
Delivers as much light as larger fixtures while taking up half the space



**QUIET CEILINGS**  
with Unified Glare Ratings (UGR) of less than 5



**CREATIVE FREEDOM**  
Design patterns based in pairs

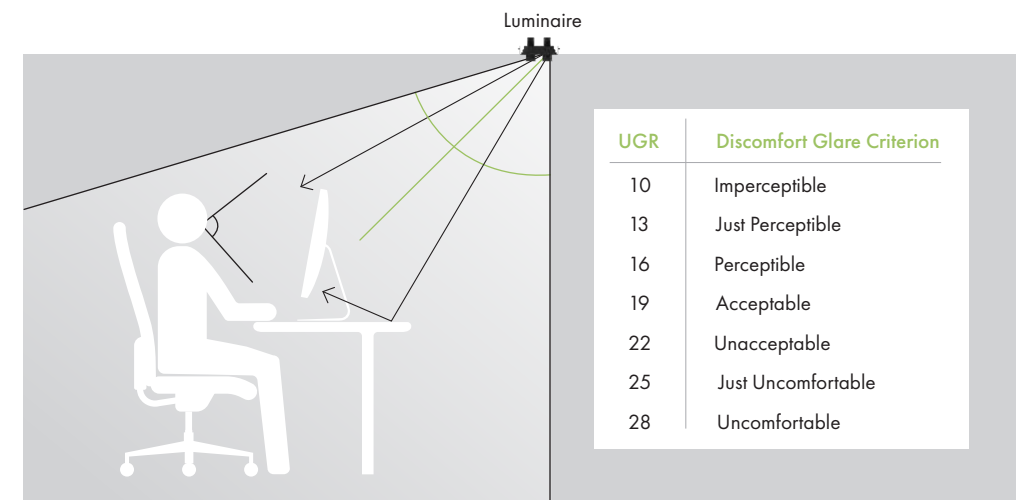

UGR Diagram for your reference only. USAI can provide you the UGR value for your specification and help your project to meet LEED(<19) and WELL(<19) requirement for glare control.

Double downlights provide excellent general illumination while minimizing brightness and maximizing visual comfort. LittleOnes Micro Doubles downlight can provide a perfect lighting solution in every space.

# LIGHTING FOR THE OFFICE

Light up open office spaces for focus, collaboration, and work. By installing **the LittleOnes Micro Doubles** black bevel fixture with a 4' x 4' fixture spacing in a 9' high ceiling space, we achieve average recommended light levels on all surfaces with an outstanding low glare score.

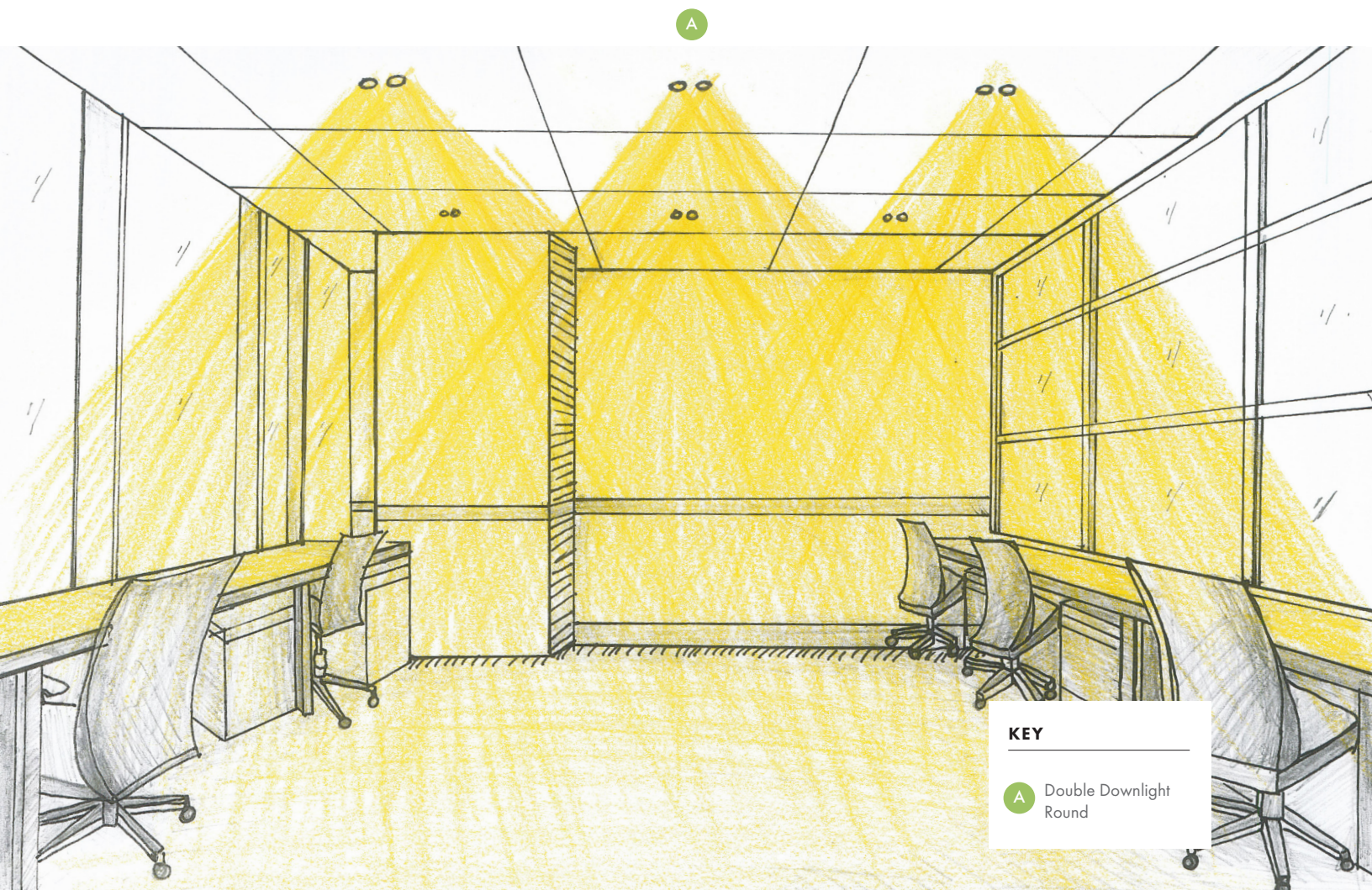

## LAYER A SPECIFICATION:

Double Downlight Round

FIXTURE SPEC: 2X M1RDF-07X4C-30KS-50-M0-BL-WH

BEAM ANGLE: 50°

WATTAGE: 14W

COLOR TEMPERATURE: 3000K, 80+ CRI

DELIVERED LIGHT: 750 Lumens

EFFICIENCY: 53 Lumen/Watt

GLARE (UGR): 9.0

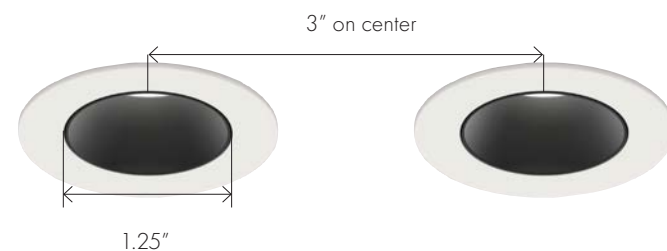

## Small and Powerful In Pairs

Below we show a plan view of the lighting calculation for this room. Here we can demonstrate that **the LittleOnes Micro Doubles** downlight can deliver 30 footcandles on the workplane and over 20 footcandles on the floor when installed in a 9' high ceiling and spaced 4' apart. These light levels meet IES recommendations and provide plenty of illumination for computer work, paperwork, and more – making for a productive and efficient workplace.

### FLOOR PLAN

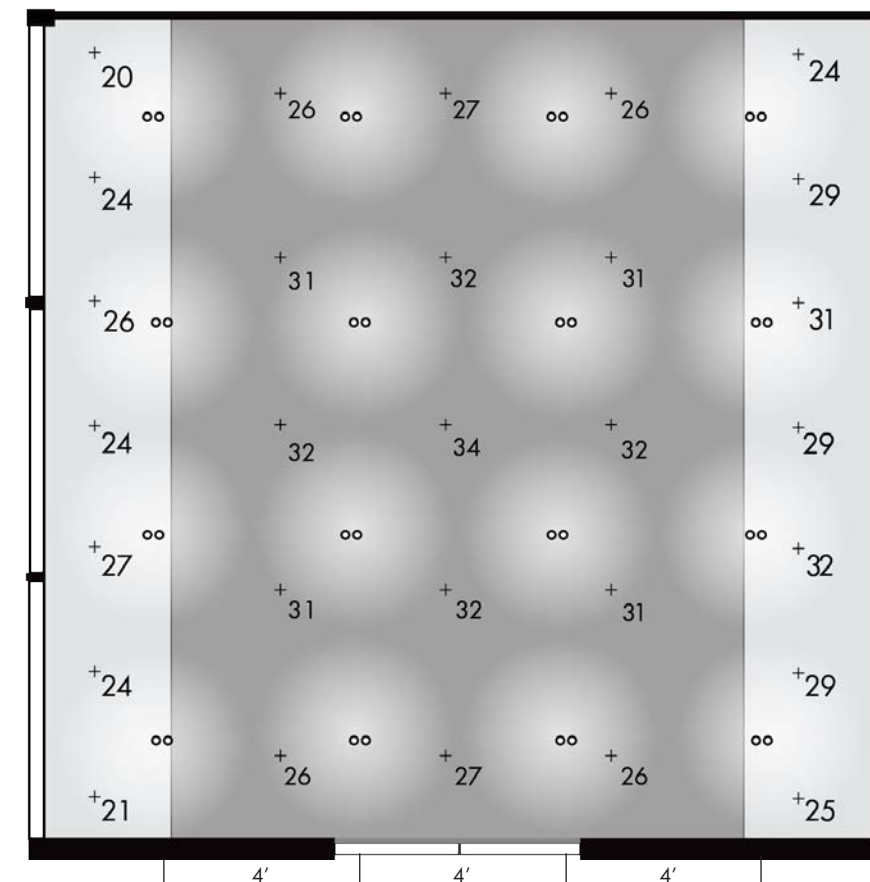

### ← LIGHTING INTENSITY

Avg On Wall: 7 FC  
Avg/Min On Wall: 6

Avg On Floor: 30 FC  
Max/Min On Floor: 1.3

Avg On Desk: 28 FC  
Max/Min On Desk: 1.3

ROOM DIMENSION:  
20'W x 20'L x 9'H

TABLE DIMENSION:  
2'W x 20'L x 2'-6"H

NOTE: Light level calculations reflectance values use standard 20% for floors, 50% for walls, and 80% for ceilings.

### 50° Beam Distribution

The 50° beam distribution specified with this **LittleOnes Micro Doubles** downlight provides a smooth, even illuminance on both the workplane and the floor, with excellent uniformity.

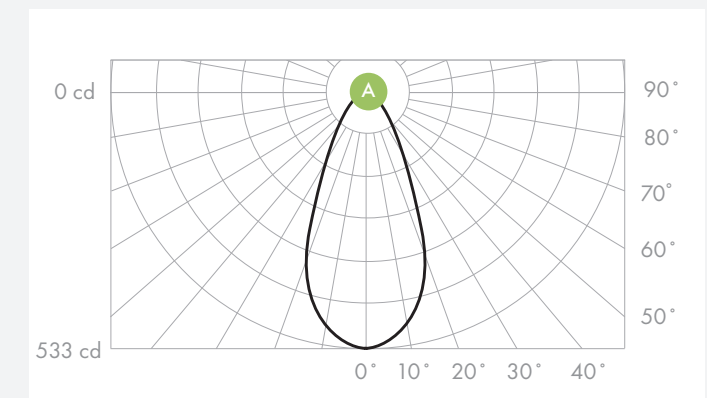

## CIRCULATION LIGHTING WITH DOUBLE DOWNLIGHT

Clearly light the way for corridors and navigation. In a typical 6' wide corridor, **the LittleOnes Micro Doubles downlight** can provide gentle, ambient side light on walls and plenty of light for the floor plane, enabling safe and secure transitions from space to space. For more ideas on how to light corridors with **the LittleOnes Micro Doubles**, see pages 13 and 17 of this guide!



### LAYER A SPECIFICATION:

Double Downlight Square

FIXTURE SPEC: 2X M1 SDF-07X4C-30KS-50-M0-BL-WH

BEAM ANGLE: 50°

WATTAGE: 14W

COLOR TEMPERATURE: 3000K, 80+ CRI

DELIVERED LIGHT: 825 Lumens

EFFICIENCY: 59 Lumen/Watt

GLARE (UGR): 13.6

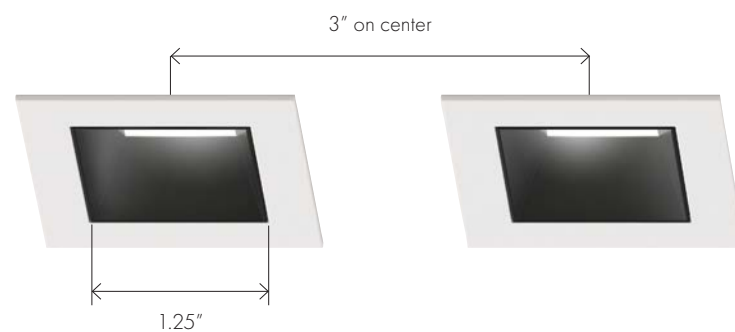

## Navigating Paths

In the application below, we show that a 6' on center spacing of **the LittleOnes Micro Doubles downlight** in a 6' wide, 8' ceiling hallway provides enough vertical light in the periphery for safe and secure wayfinding, and floor illumination that is above IES recommended light levels.

### ELEVATION VIEW



### FLOOR PLAN

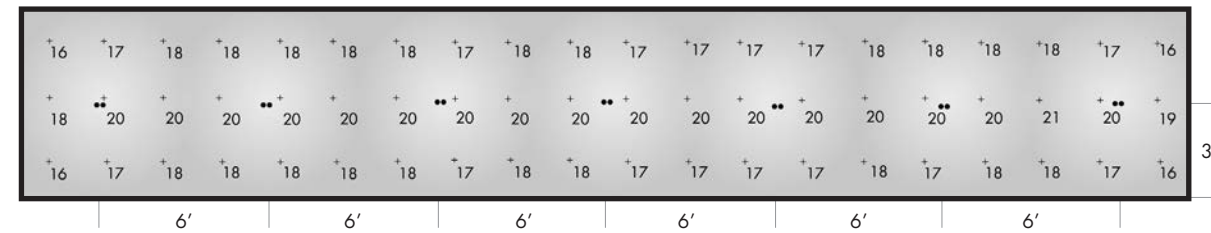

### LIGHTING INTENSITY

Avg On Wall: 5 FC

Max/Min On Wall: 3.5

Avg On Floor: 18.3 FC

Max/Min On Floor: 1.3

### ROOM DIMENSION:

6'W x 40'L x 8'H

**NOTE:** Light level calculations reflectance values use standard 20% for floors, 50% for walls, and 80% for ceilings.

### 50° Beam Distribution

By orienting **the LittleOnes Micro Doubles downlight** lengthwise down the corridor, we are able to spread the light uniformly along the length of the hall without shadows, scallops or dark spots.

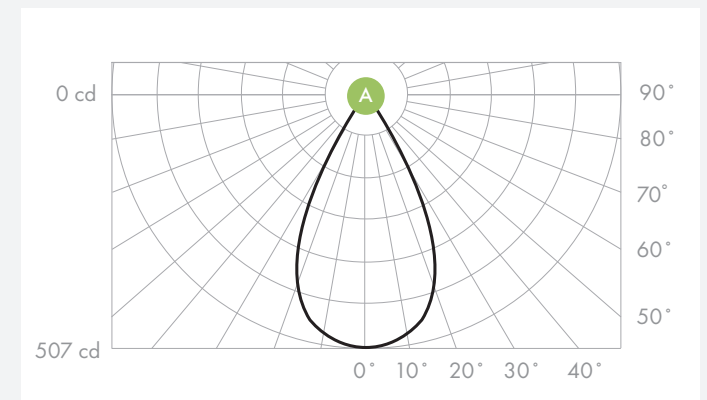

# DOUBLE WALL WASH

Uniform Brightness from Ceiling to Floor



## VERTICAL ILLUMINATION

Vertical light enhances the perception of brightness in an interior space. There are multiple ways to achieve this with **the LittleOnes Micro Doubles Wall Wash**. Choose to have the two heads pointed together at the same wall for increased light levels, or rotate one or both of the heads away from each other to light adjacent walls in a corner, or opposite walls in a corridor. The possibilities are endless.

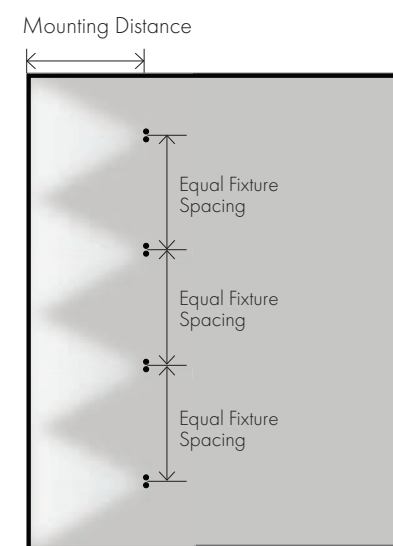

**Wall Wash Mounting Recommendation:**  
 Mounting Distance = 2'-0" - 3'-6"  
 Fixture Spacing = 2'-6" - 4'-0"

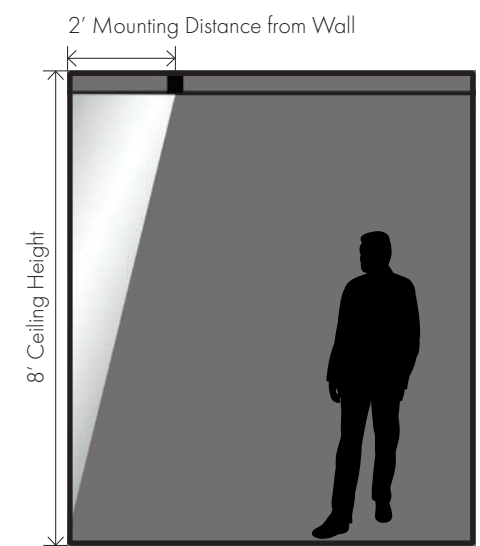

Need help determining the perfect wall wash layout?  
 Contact USAI for applications assistance.

# CIRCULATION LIGHTING WITH DOUBLE WALLWASH

Clearly illuminate the way for corridors and navigation. In this typical 6' wide corridor, the **LittleOnes Micro Doubles Wall Wash** is aimed at opposite walls to emphasize the vertical plane so the room periphery feels bright. This approach also provides indirect lighting on the floor, ensuring safe and comfortable transitions from space to space.

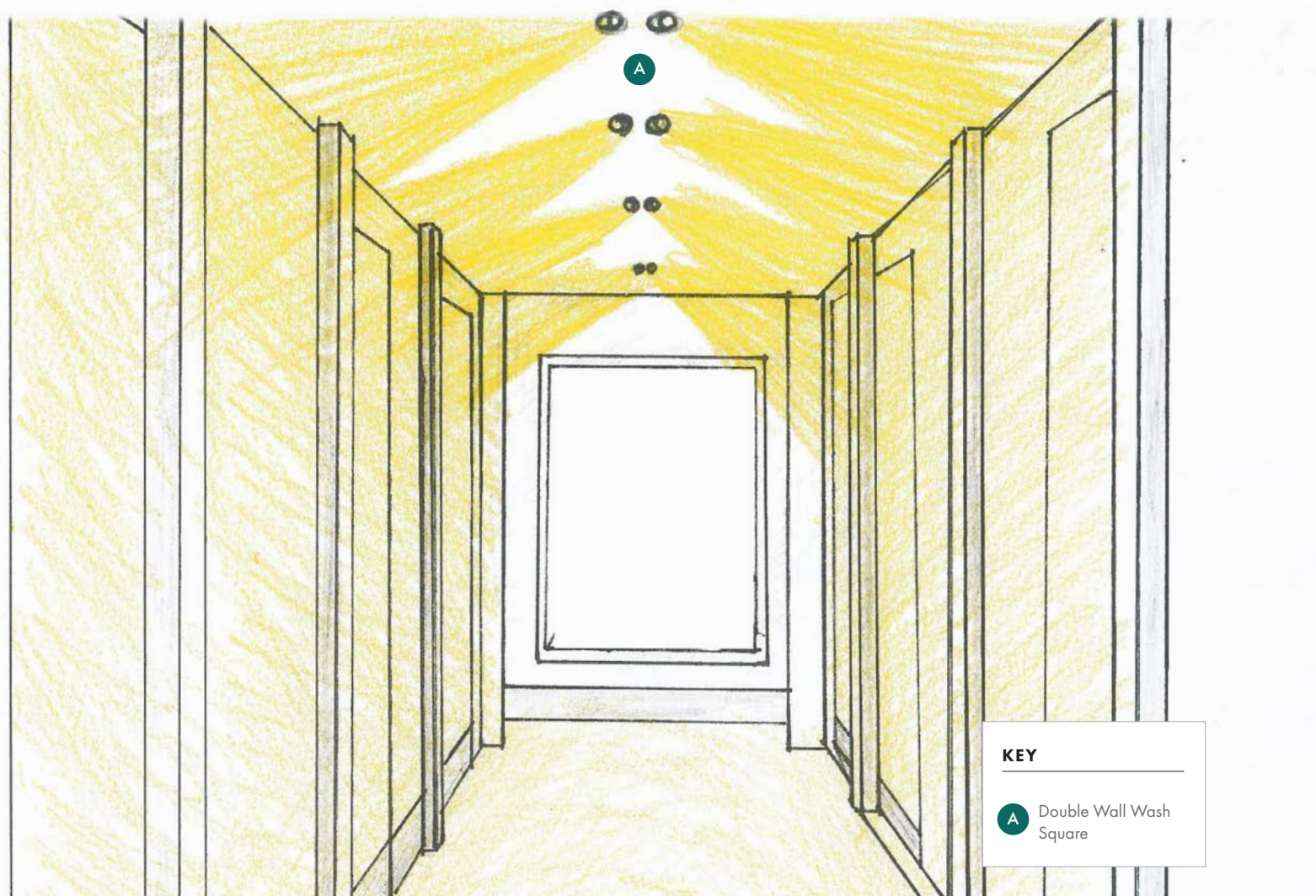

**KEY**  
 A Double Wall Wash Square

## LAYER A SPECIFICATION:

Double Wall Wash Square

**FIXTURE SPEC:** 2X M1SWF-07X4C-30KS-W2-D1-WH

**WATTAGE:** 14W

**COLOR TEMPERATURE:** 3000K, 80+ CRI

**DELIVERED LIGHT:** 700 Lumens

**EFFICIENCY:** 50 Lumen/Watt

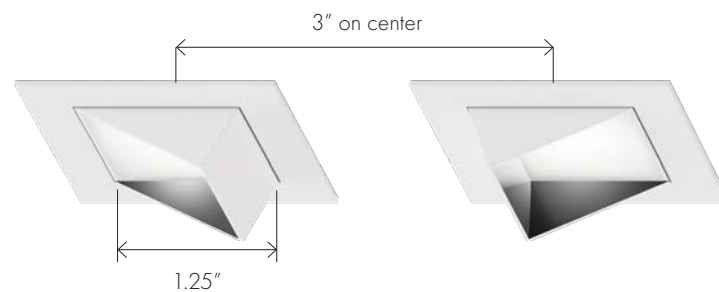

# Navigating Paths

In the application shown below, we demonstrate that the **LittleOnes Micro Doubles Wall Wash** can be spaced 4' on center in an 8' ceiling to achieve above recommended IES light levels in the corridor.

## ELEVATION



## PLAN VIEW

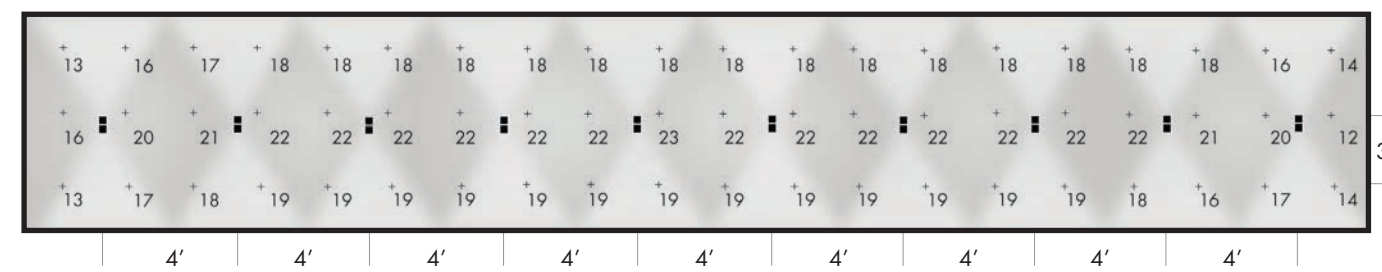

## LIGHTING INTENSITY

Avg On Wall: 7 FC      Avg On Floor: 19 FC  
 Max/Min On Wall: 3      Max/Min On Floor: 1.7

## ROOM DIMENSION:

6'W x 40'L x 8'H

**NOTE:** Light level calculations reflectance values use standard 20% for floors, 50% for walls, and 80% for ceilings.

## Wall Wash Distribution

The **LittleOnes Micro Wall Wash** optical solution is best in class. Reaching to the top of the wall, with little to no backlight and excellent wall uniformity using typical mounting and spacing ratios, this tiny fixture outperforms many of its larger competitors.

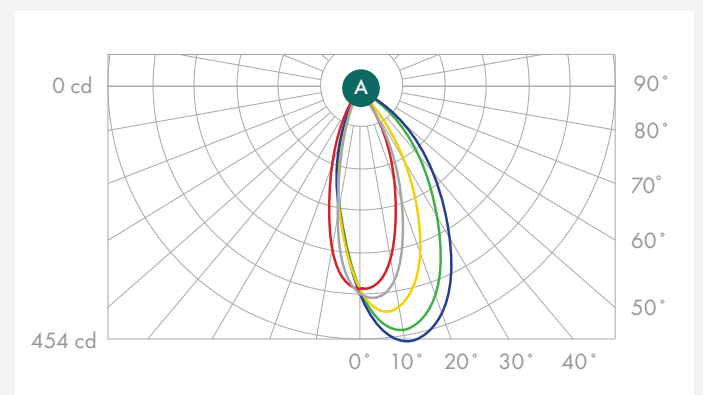

● -0°H    ● -90°H    ● -22.5°H    ● -45°H    ● -67.5°H



# MIX AND MATCH

Create your own Doubles with  
One Downlight + One Wall Wash

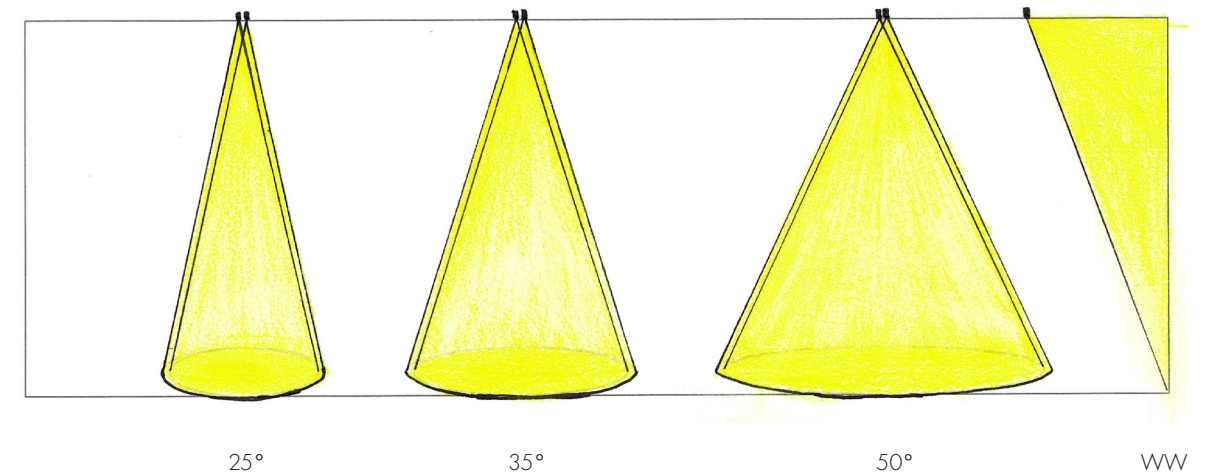

## MIX AND MATCH MULTIPLE FUNCTIONS IN A SINGLE FIXTURE

Downlight and Wall Wash functions can be combined within **the LittleOnes Micro Doubles** fixture housing, whether round or square. Choose from our wide range of downlight distributions - **25°**, **35°**, or **50°** - or wall wash, with lens accessory options such as hexcell louvers, color shifting CTO filters, or linear spread lens options for the ultimate in design flexibility. A solution for every space is possible with this light fixture.

# CIRCULATION LIGHTING WITH DOWNLIGHT & WALLWASH

Yet another way to light a corridor. This design scheme balances the downlight component with vertical light on one wall side using a combination downlight + wall wash light fixture. Using a 2700K, 90+ CRI color temperature for the downlight component makes the space feel warm and people look their best.

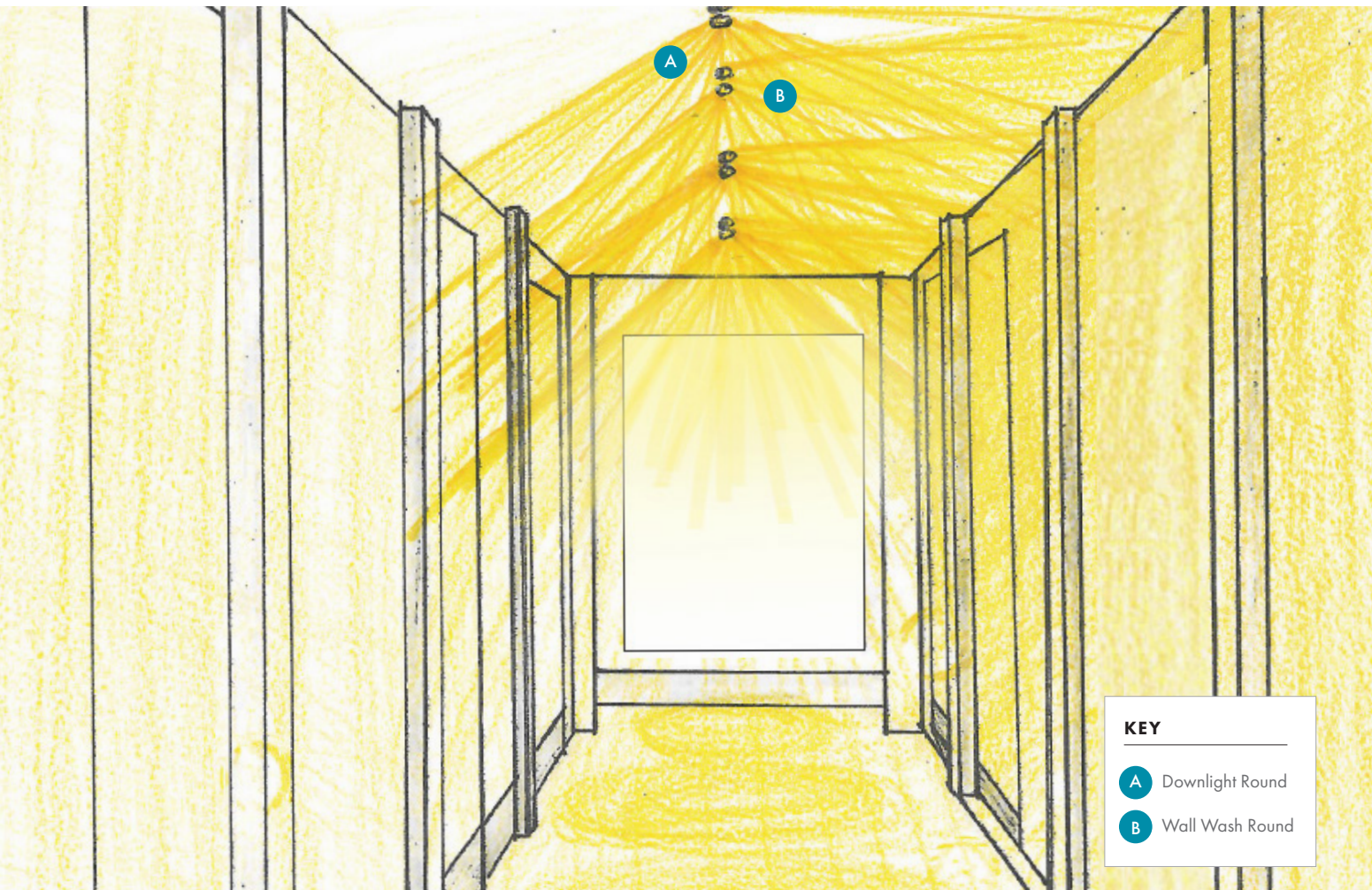

**KEY**

- A Downlight Round
- B Wall Wash Round

**LAYER A SPECIFICATION:**

- Downlight Round
- FIXTURE SPEC:** M1RDL-07X4C-27KH-50-M0-WH
- BEAM ANGLE:** 50°
- WATTAGE:** 7W
- COLOR TEMPERATURE:** 2700K, 90CRI
- DELIVERED LIGHT:** 425 Lumens
- EFFICIENCY:** 61 Lumen/Watt
- GLARE (UGR):** 27.9

**LAYER B SPECIFICATION:**

- Wall Wash Round
- FIXTURE SPEC:** M1RWL-07X4C-27KH-W2-D1-WH
- WATTAGE:** 7W
- COLOR TEMPERATURE:** 2700K, 90+ CRI
- DELIVERED LIGHT:** 325 lumens
- EFFICIENCY:** 47 Lumen/Watt



## Balancing Brightness

In the application shown below, we demonstrate that the combination downlight and wall wash double fixture can be spaced 4' on center in an 8' high ceiling to achieve above recommended IES light levels on the corridor floor, and an even wall illuminance at the same time.

**ELEVATION VIEW**

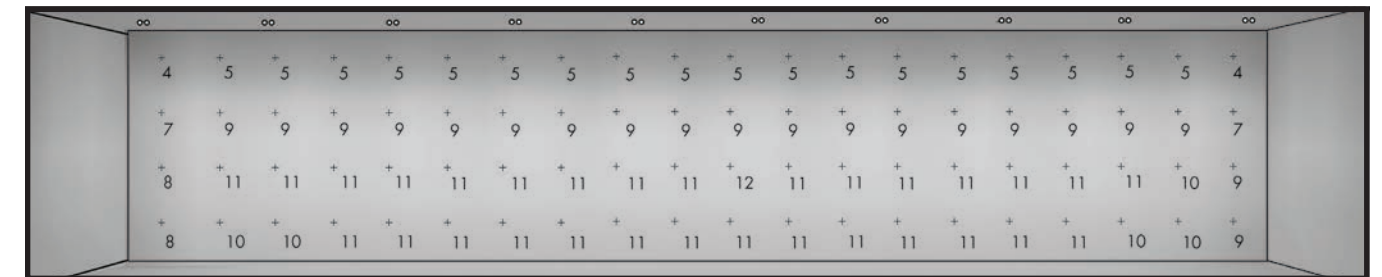

**PLAN VIEW**

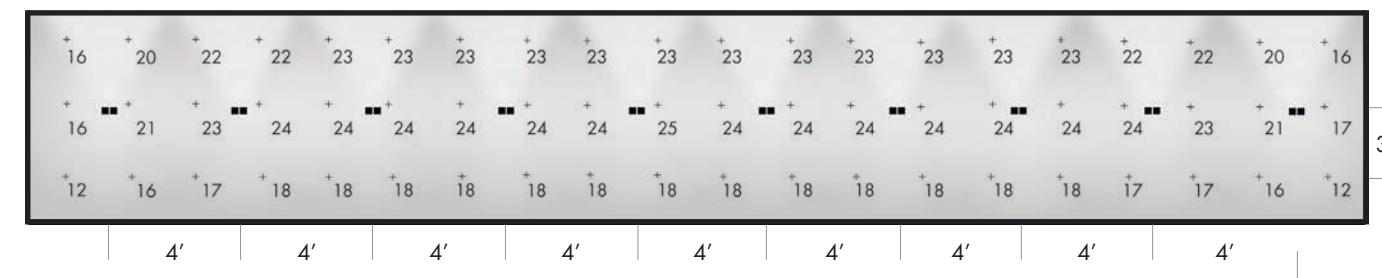

**LIGHTING INTENSITY**

Avg On Wall: 9 FC  
Max/Min On Wall: 2

Avg On Floor: 22 FC  
Max/Min On Floor: 2

**ROOM DIMENSION:**

6'W x 40'L x 8'H

**NOTE:** Light level calculations reflectance values use standard 20% for floors, 50% for walls, and 80% for ceilings.

**50° Downlight + Wall Wash Distribution**

Different beamspreads, color temperatures, and color rendering index may be specified for the two individual fixture heads in a Double.

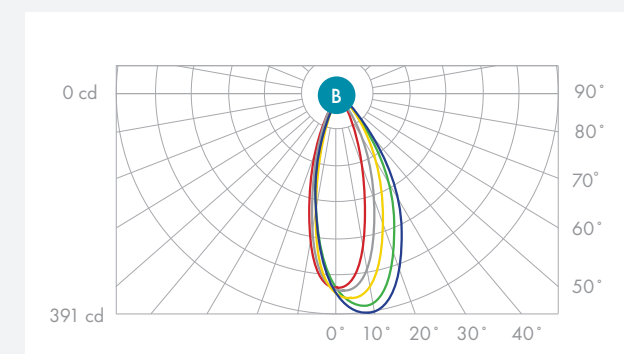
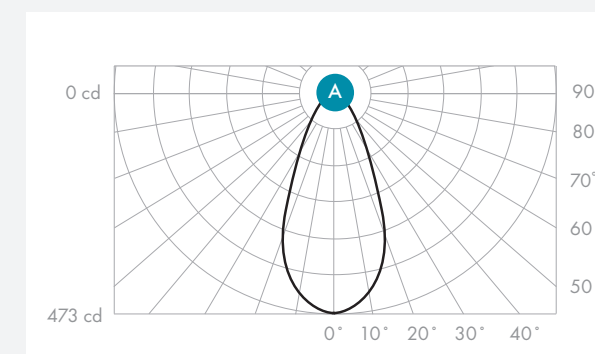

● -0°H ● -90°H ● -22.5°H ● -45°H ● -67.5°H

# LIGHTING FOR A WELCOMING RECEPTION SPACE

Mix and match downlight with wall wash for a welcoming reception space. The wall wash provides highlights for vertical surfaces and the downlight provides general illumination for comfortable transitions, arrivals and departures.

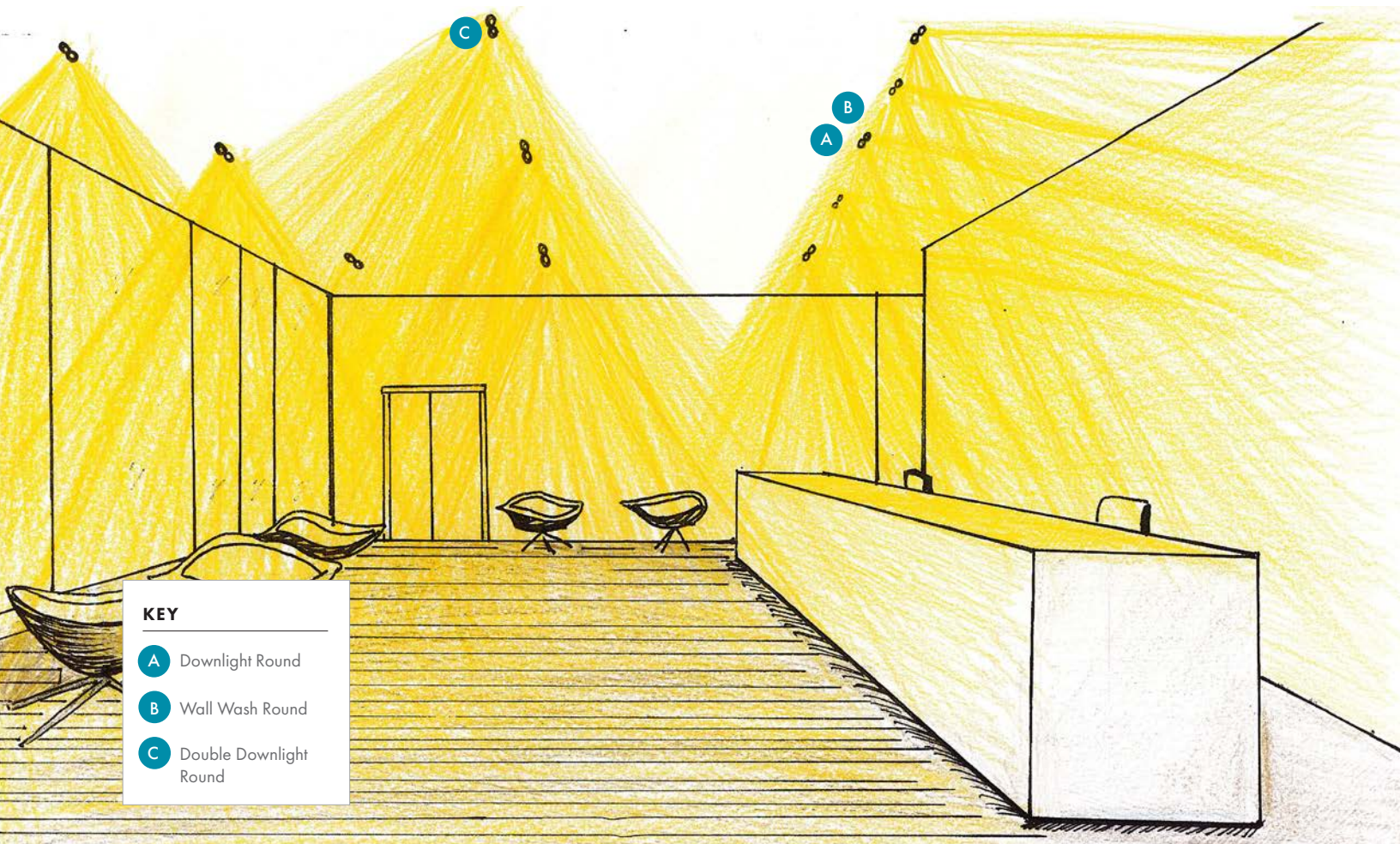

- KEY**
- A Downlight Round
  - B Wall Wash Round
  - C Double Downlight Round

**LAYER A SPECIFICATION:**

Downlight Round

---

**FIXTURE SPEC:**  
M1RDF-07X4C-30KS-35-M0-WH

**BEAM ANGLE:** 35°

**WATTAGE:** 7W

**COLOR TEMPERATURE:**  
3000K, 80+ CRI

**DELIVERED LIGHT:** 625 Lumens

**EFFICIENCY:** 90 Lumen/Watt

**GLARE (URG):** 15.6

**LAYER B SPECIFICATION:**

Wall Wash Round

---

**FIXTURE SPEC:**  
M1RWF-07X4C-30KS-W2-D1-WH

**WATTAGE:** 7W

**COLOR TEMPERATURE:**  
3000K, 80+ CRI

**DELIVERED LIGHT:** 325 Lumens

**EFFICIENCY:** 47 Lumen/Watt

**LAYER C SPECIFICATION:**

Double Downlight Round

---

**FIXTURE SPEC:**  
2X M1RDF-07X4C-30KS-50-M0-WH

**BEAM ANGLE:** 50°

**WATTAGE:** 14W

**COLOR TEMPERATURE:**  
3000K, 80+ CRI

**DELIVERED LIGHT:** 1100 Lumens

**EFFICIENCY:** 78 Lumen/Watt

**GLARE (URG):** 28.7

## Relaxing Arrivals

In the application below, a combination downlight + wall wash fixture is used in a 3' on center spacing to highlight the reception desk and also illuminate the wall behind it, while double downlight fixtures are used in a 6' x 6' spacing to provide general illumination in the rest of this generous 12' ceiling space.

**FLOOR PLAN**

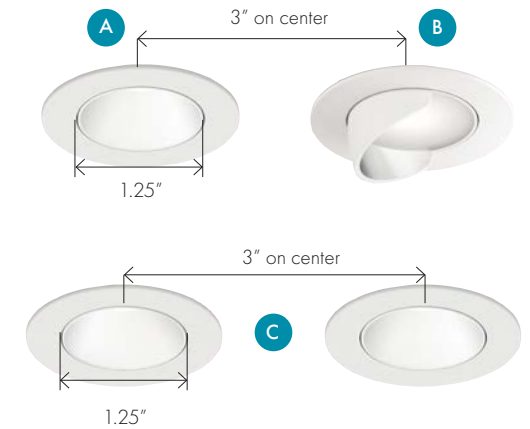
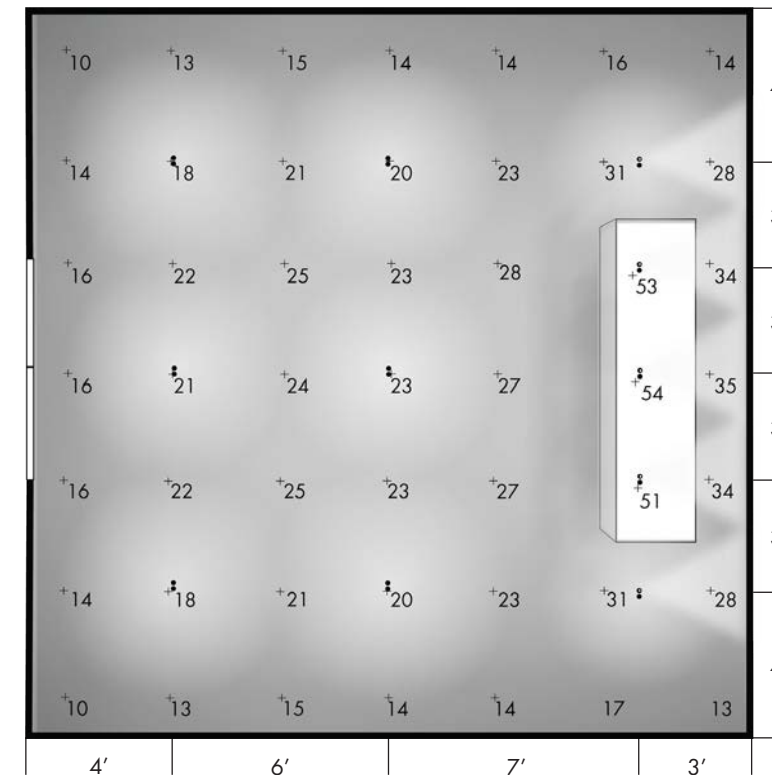

← **LIGHTING INTENSITY**

**Avg On Floor:** 20.5 FC  
**Avg/Min On Floor:** 2

**Avg On Desk:** 52 FC  
**Avg/Min Desk:** 1

**Avg On Feature Wall:** 9.6 FC  
**Avg/Min On Feature Wall:** 3.2

**ROOM DIMENSION:**  
20'W x 20'L x 12'H

**COUNTER HEIGHT:** 3'H

**NOTE:** Light level calculations reflectance values use standard 20% for floors, 50% for walls, and 80% for ceilings.

### 35° Downlight + Wall Wash Distribution

Different beamspreads, color temperatures, and color rendering index may be specified for the two individual fixture heads in a Double.

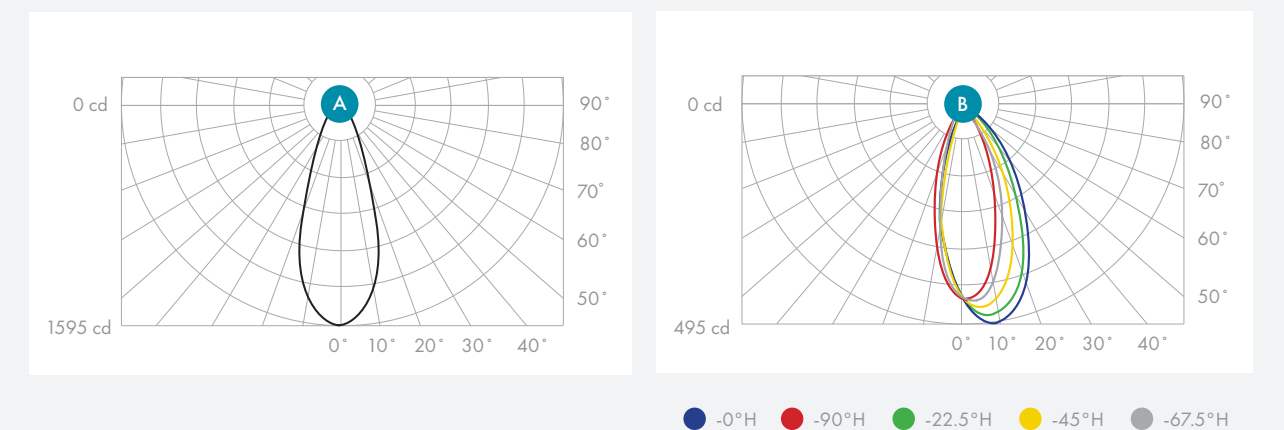

# LIGHT FOR RESIDENTIAL SPACES

Lighting that becomes warmer as you dim it down provides a cozy feeling for residential spaces.

The **LittleOnes Micro Doubles Dim-to-Warm** option starts at **3000K** at 100% light level and gradually warms to an amber **2000K** at the lowest light level setting. This allows for dynamic mood setting between daytime and night in a multipurpose space like this one.



**KEY**

- A Double Downlight Round
- B Double Wall Wash Round

**LAYER A SPECIFICATION:**

Double Downlight Round

**FIXTURE SPEC:**  
2x M1RDL-07DW2-3020KH-50-M0-WH

**BEAM ANGLE:** 50°

**WATTAGE:** 14W

**COLOR TEMPERATURE:**  
3000K-2000K, 90+ CRI

**DELIVERED LIGHT:** 700 Lumens

**EFFICIENCY:** 50 Lumen/Watt

**GLARE (URG):** 26.6

**LAYER B SPECIFICATION:**

Double Wall Wash Round

**FIXTURE SPEC:**  
2x M1RWL-07DW2-3020KH-W2-D1-WH

**WATTAGE:** 14w

**COLOR TEMPERATURE:**  
3000K-2000K, 90+ CRI

**DELIVERED LIGHT:** 525 Lumens

**EFFICIENCY:** 32 Lumen/Watt

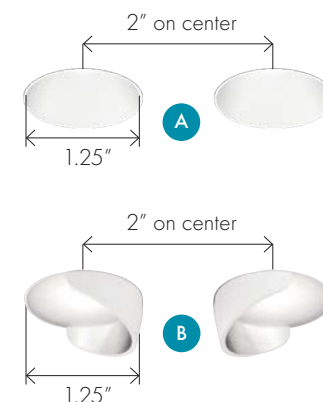

## Warm Ambiance

In this residential space, we show the **LittleOnes Micro Doubles Downlight** provides general illumination for living areas. The **LittleOnes Micro Doubles Wall Wash** evenly lights the art and family photographs placed on walls, all with a consistent below-ceiling aesthetic.

**FLOOR PLAN**

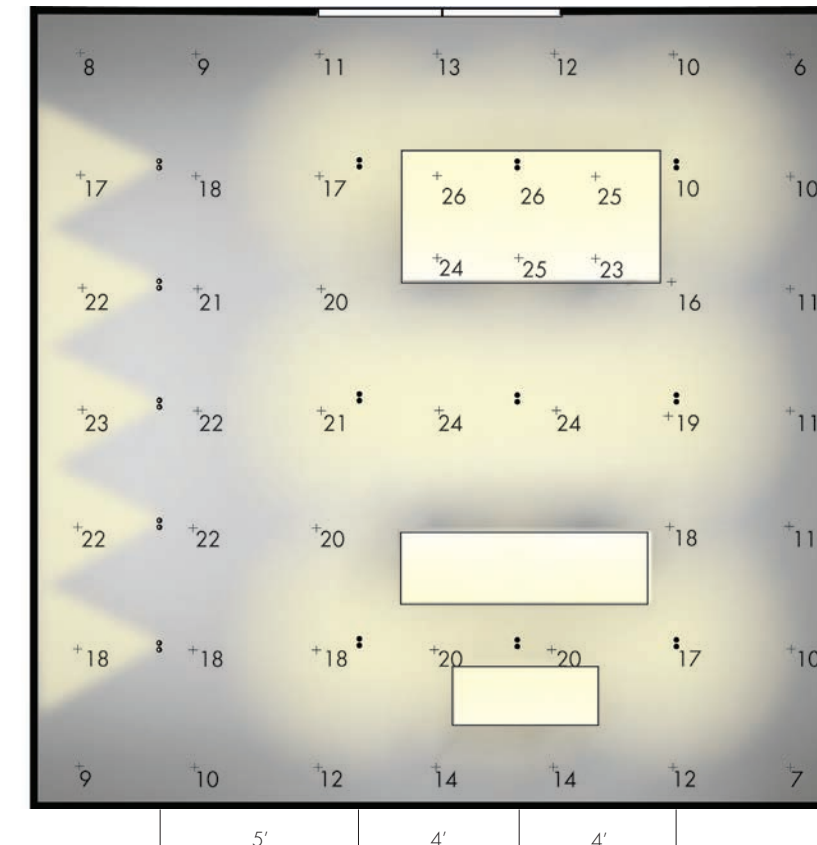

← **LIGHTING INTENSITY**

Avg On Floor: 15.5 FC  
Avg/Min On Floor: 2.6

Avg On Desk: 25 FC  
Avg/Min Desk: 1

Avg On Feature Wall: 7.3 FC  
Avg/Min On Feature Wall: 7.3

**ROOM DIMENSION:**  
20'W x 20'L x 10'H

**TABLE HEIGHT:** 3'H

**NOTE:** Light level calculations reflectance values use standard 20% for floors, 50% for walls, and 80% for ceilings.

### 50° Downlight + Wall Wash Distribution

All of the **LittleOnes Micro Doubles** beamspread options are available with USAI's Dim to Warm LED color option.

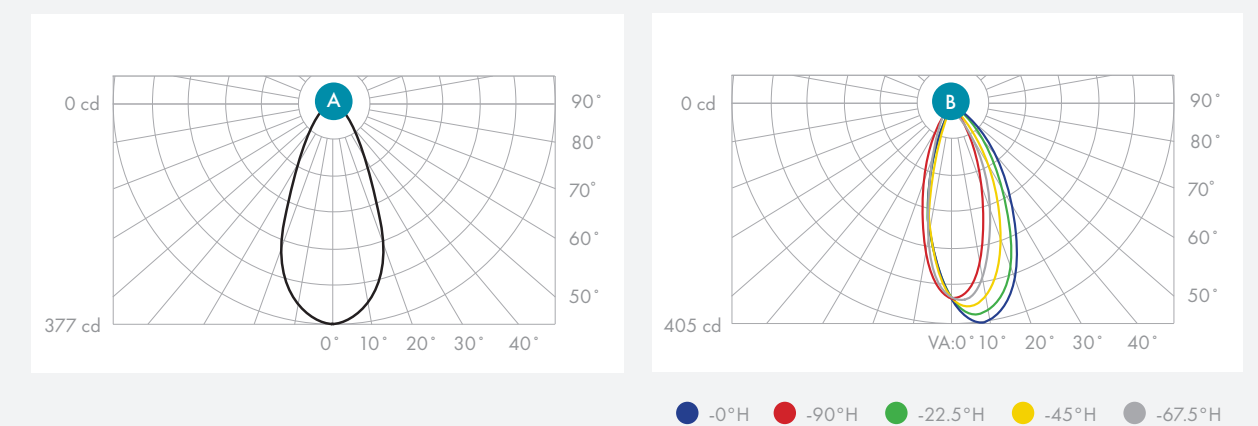

# DOUBLE ADJUSTABLE

Ideal for Highlighting Artwork and Displays



## FULL ADJUSTABILITY FREEDOM

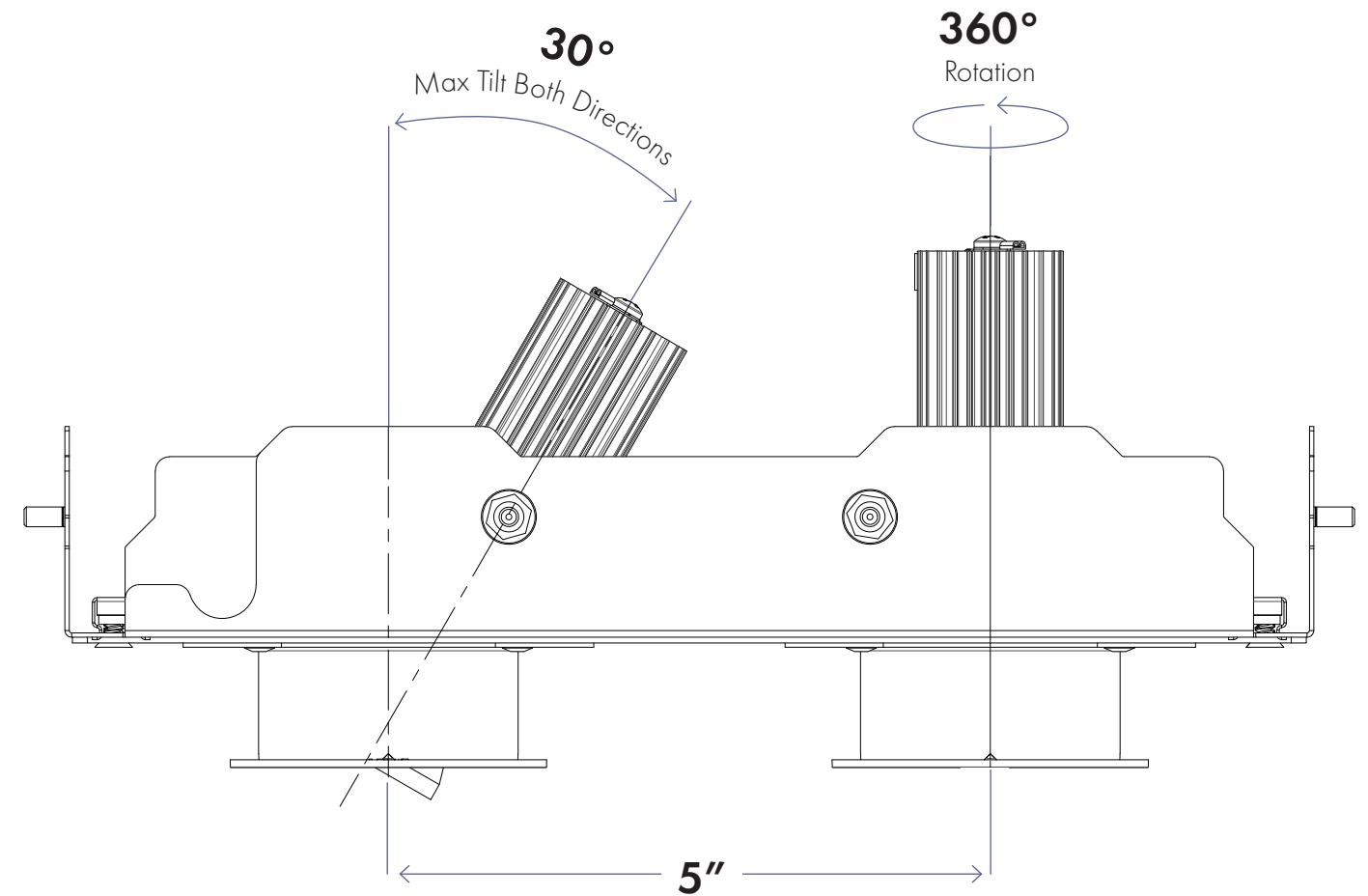

With the **LittleOnes Micro Doubles Adjustable** fixture, each of the two fixture heads are independently adjustable, and can be rotated **360°** and tilted up to **30° maximum in either direction** without interference from the other head - making lighting corners and highlighting special objects a breeze.

# LIGHT FOR DISPLAY

When you walk into a retail space your eyes are naturally attracted to the brightest surface in the room.

The **LittleOnes Micro Doubles Adjustable** enhances the retail experience by offering **90 CRI**, high lumen output and narrow beams to focus on the specific objects you intend to highlight.

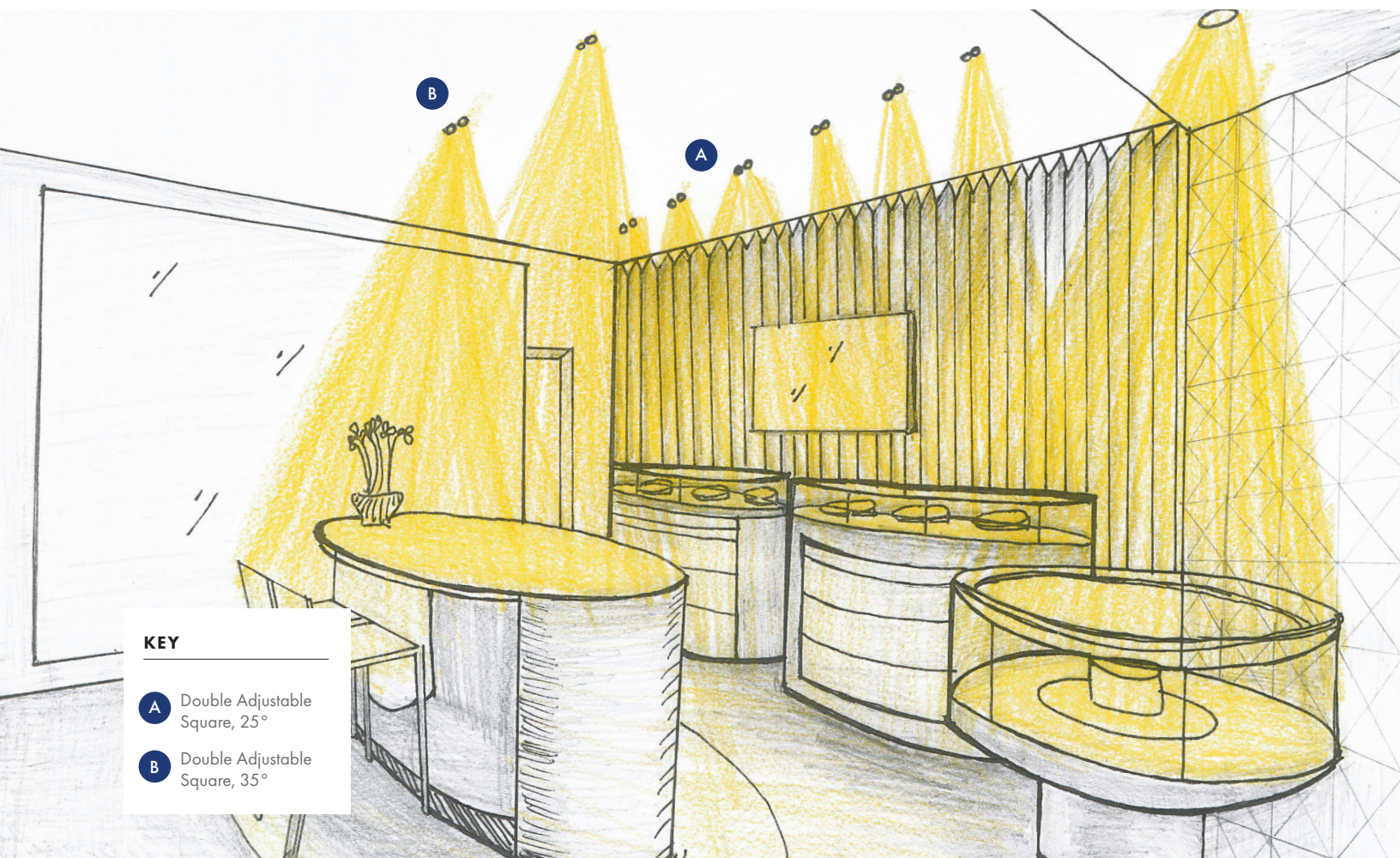

**KEY**

- A** Double Adjustable Square, 25°
- B** Double Adjustable Square, 35°

**LAYER A SPECIFICATION:**

Double Adjustable Square, 25°

**FIXTURE SPEC:**  
2X M1 SAL-07X4C-40KH-25-M0-WH

**BEAM ANGLE:** 25°

**WATTAGE:** 14W

**COLOR TEMPERATURE:** 4000K, 90CRI

**DELIVERED LIGHT:** 1025 Lumens

**EFFICIENCY:** 73 Lumen/Watt

**GLARE (UGR):** 13.9

**LAYER B SPECIFICATION:**

Double Adjustable Square, 35°

**FIXTURE SPEC:**  
2X M1 SAL-07X4C-40KH-35-M0-WH

**BEAM ANGLE:** 35°

**WATTAGE:** 14W

**COLOR TEMPERATURE:** 4000K, 90CRI

**DELIVERED LIGHT:** 1100 Lumens

**EFFICIENCY:** 78 Lumen/Watt

**GLARE (UGR):** 15.1

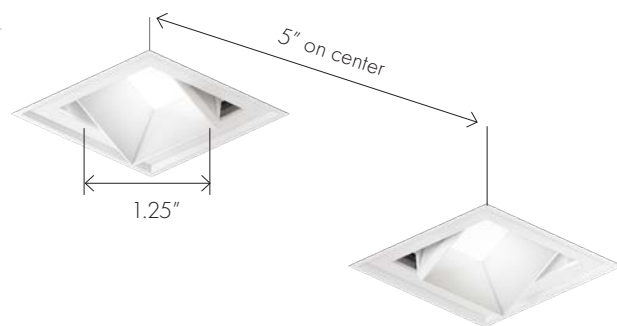

# Directing Attention

In the retail space below, narrow 25° beams and high color temperatures are used to highlight glass cases, and medium 35° beams are used to light consultation areas at a slightly lower light level.

**FLOOR PLAN**

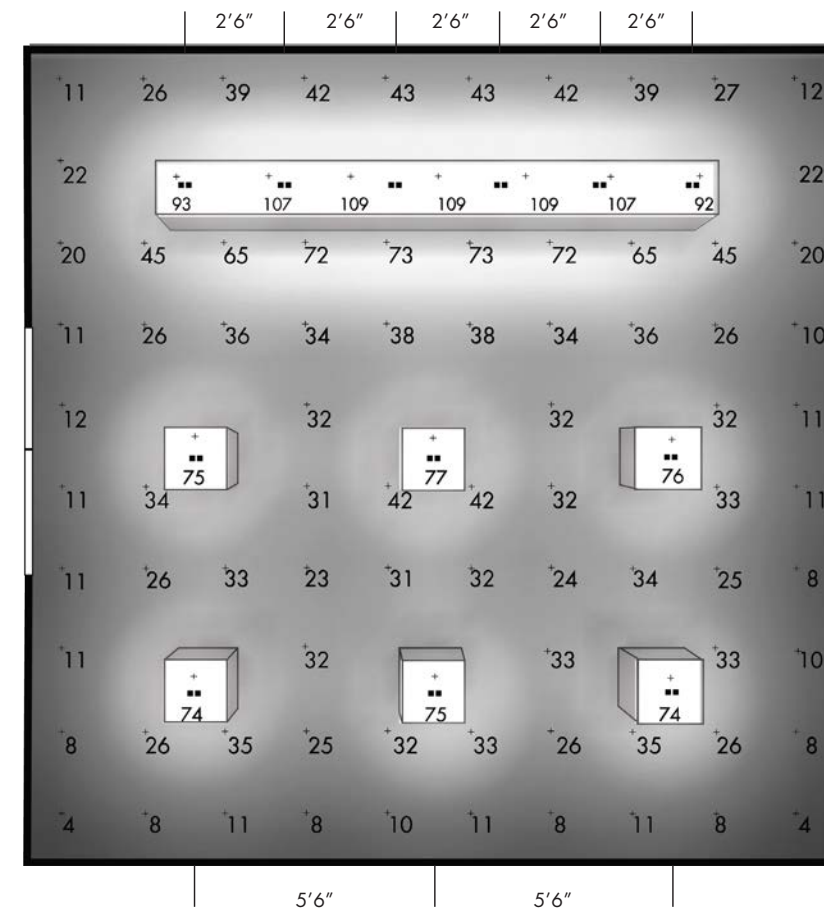

**LIGHTING INTENSITY**

Avg On Floor: 29 FC  
Avg/Min On Floor: 7

Avg On Long Jewelry Case: 104 FC  
Avg/Min Long Jewelry Case: 1

Avg On Small Jewelry Case: 78 FC  
Avg/Min Small Jewelry Case: 1

**ROOM DIMENSION:**  
20'W x 20'L x 9'H

**DISPLAY CASE:** 3'H

**NOTE:** Light level calculations reflectance values use standard 20% for floors, 50% for walls, and 80% for ceilings.

**25° and 35° Beam Distributions**

By selectively applying these focused beams with the **LittleOnes Micro Doubles Adjustable**, we are able to highlight specific displays and aim the fixture heads independently.

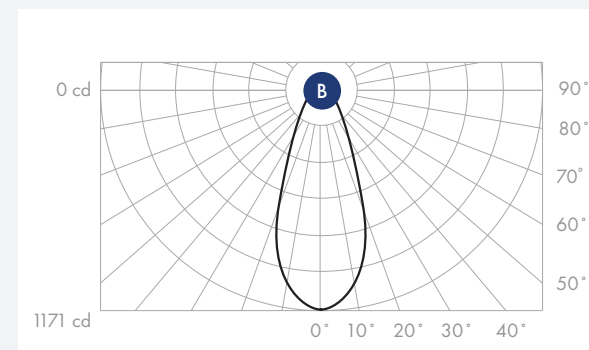
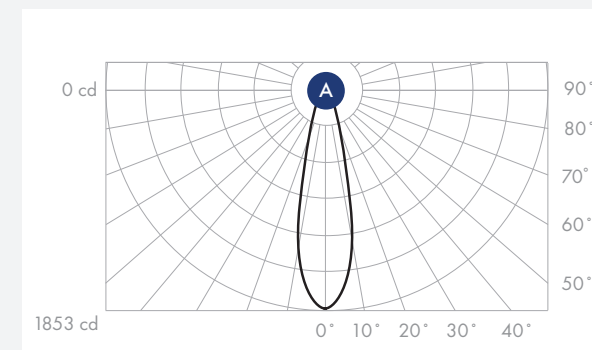

# LIGHT FOR ART

The **LittleOnes Micro Doubles Adjustable** provides all of the tools a designer needs to beautifully illuminate a space that requires flexibility. Full tilt and rotation capabilities in both fixture heads provides the range and versatility required for flood lighting, direct aiming, spotlighting, and cross-aiming.

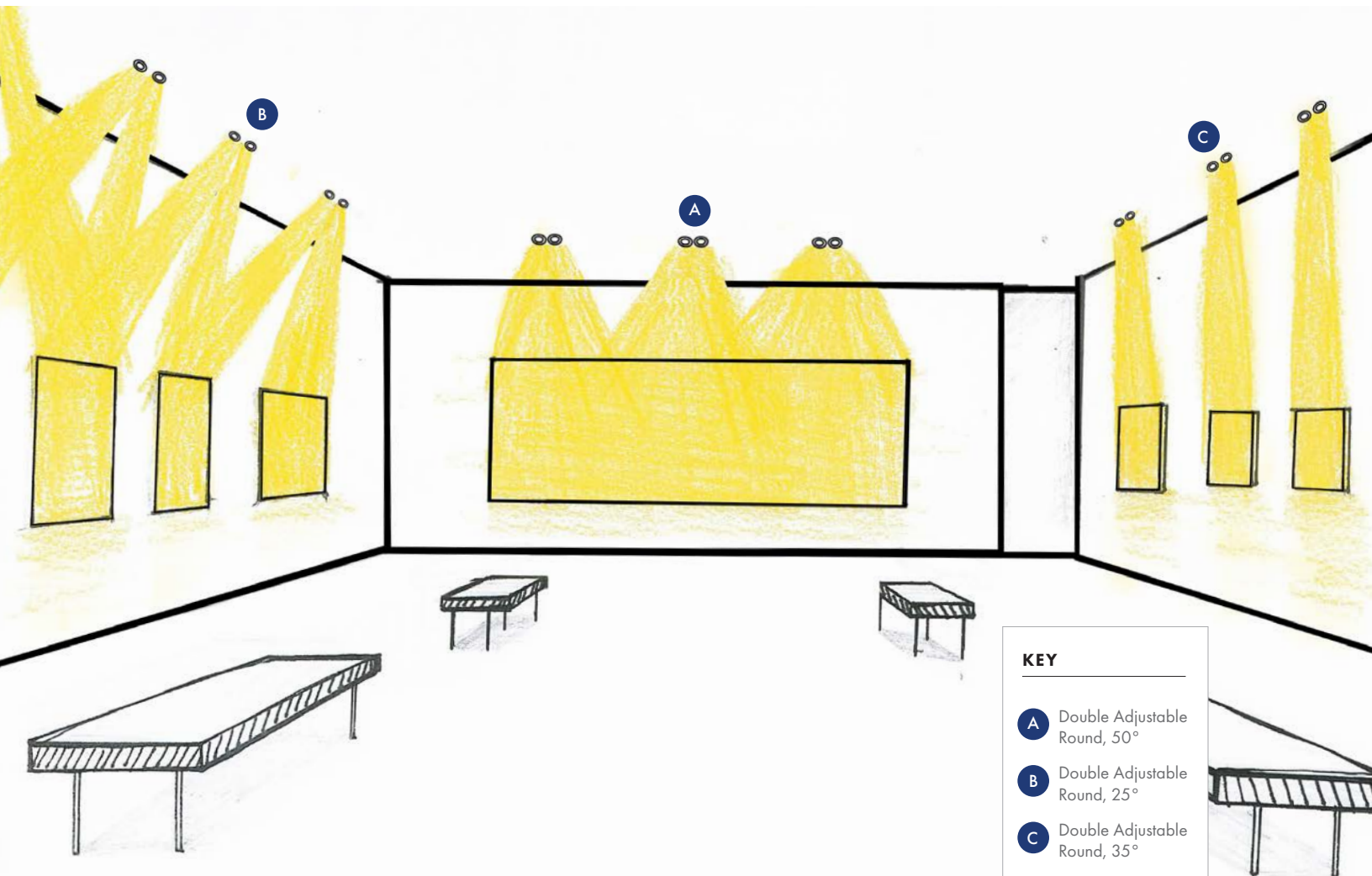

- KEY**
- A** Double Adjustable Round, 50°
  - B** Double Adjustable Round, 25°
  - C** Double Adjustable Round, 35°

**ROOM DIMENSION:** 20'W X 20'L X 9'H

**FIXTURE WALL OFFSET:** 2'-6"

**FIXTURE AIM ANGLE:** 30°

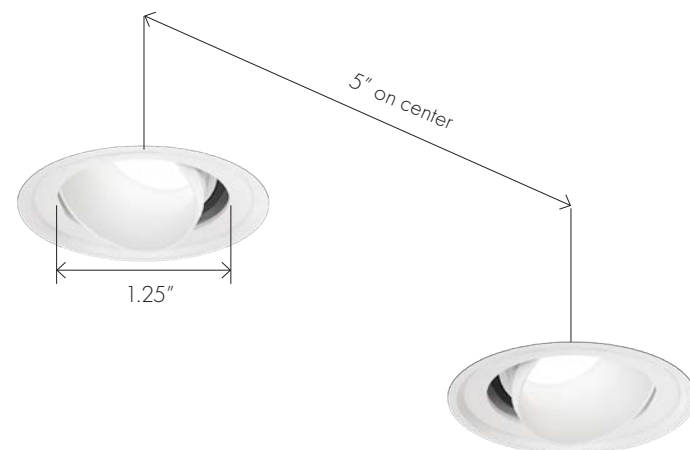

## 3 Ways to Light Art

Artwork of varying sizes and shapes may require a wide range of wall placements and light effects. In applications like these, versatility is key. In the next two sketches we will demonstrate different aiming techniques and lighting solutions for wall art of various sizes.

### LAYER A SPECIFICATION:

Double Adjustable Round, 50°

**FIXTURE SPEC:**

2x M1RAL-07X4C-30KH-50-M0-WH

**BEAM ANGLE:** 50°

**WATTAGE:** 14W

**COLOR TEMPERATURE:** 3000K, 90CRI

**DELIVERED LIGHT:** 925 Lumens

**EFFICIENCY:** 66 Lumen/Watt

**GLARE (UGR):** 28.1

### 50° Beam Distribution

The widest beam option is best for broad, soft, even lighting

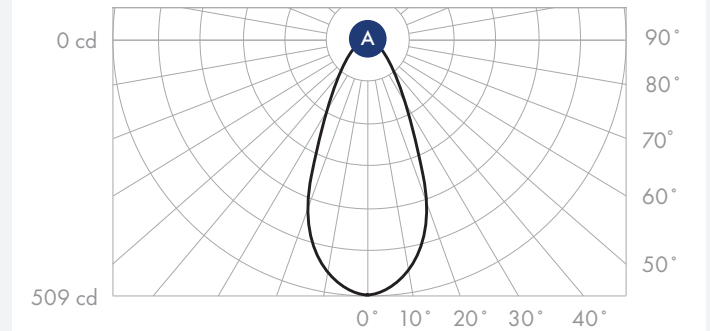

### LAYER B SPECIFICATION:

Double Adjustable Round, 25°

**FIXTURE SPEC:**

2x M1RAL-07X4C-30KH-25-M0-WH

**BEAM ANGLE:** 25°

**WATTAGE:** 14W

**COLOR TEMPERATURE:** 3000K, 90CRI

**DELIVERED LIGHT:** 950 Lumens

**EFFICIENCY:** 68 Lumen/Watt

**GLARE (UGR):** 16.9

### 25° Beam Distribution

The most narrow beam option is best for pinpointing specific areas of interest, and highlighting small objects

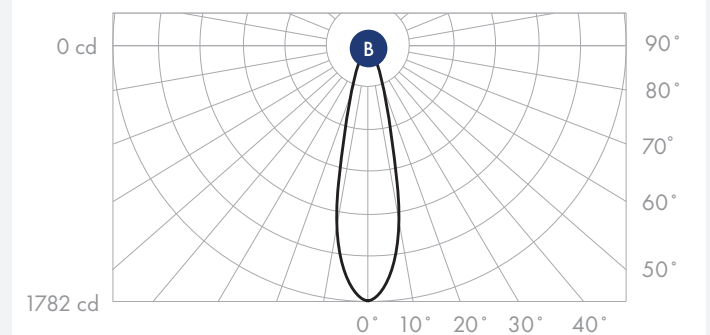

### LAYER C SPECIFICATION:

Double Adjustable Round, 35°

**FIXTURE SPEC:**

2x M1RAL-07X4C-30KH-35-M0-WH

**BEAM ANGLE:** 35°

**WATTAGE:** 14W

**COLOR TEMPERATURE:** 3000K, 90CRI

**DELIVERED LIGHT:** 1075 Lumens

**EFFICIENCY:** 77 Lumen/Watt

**GLARE (UGR):** 15.0

### 35° Beam Distribution

The medium beam option provides a nice compromise between achieving high intensity but also lighting up a larger area

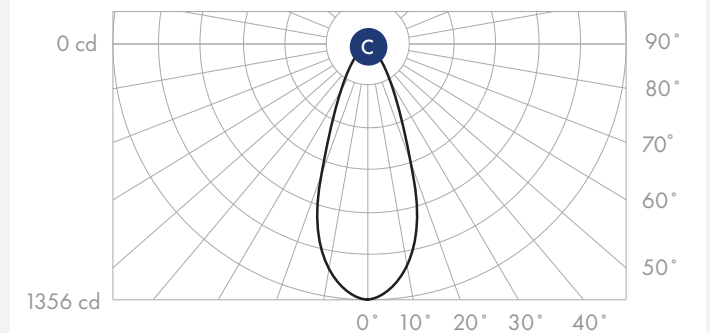

# LIGHT FOR LARGE ARTWORK

With large pieces of artwork it can be a challenge to light an entire piece evenly. By using **the LittleOnes Micro Doubles Adjustable** fixtures, both heads can be aimed independently, and the wide 50° beam ensures full coverage from both side to side and top to bottom.

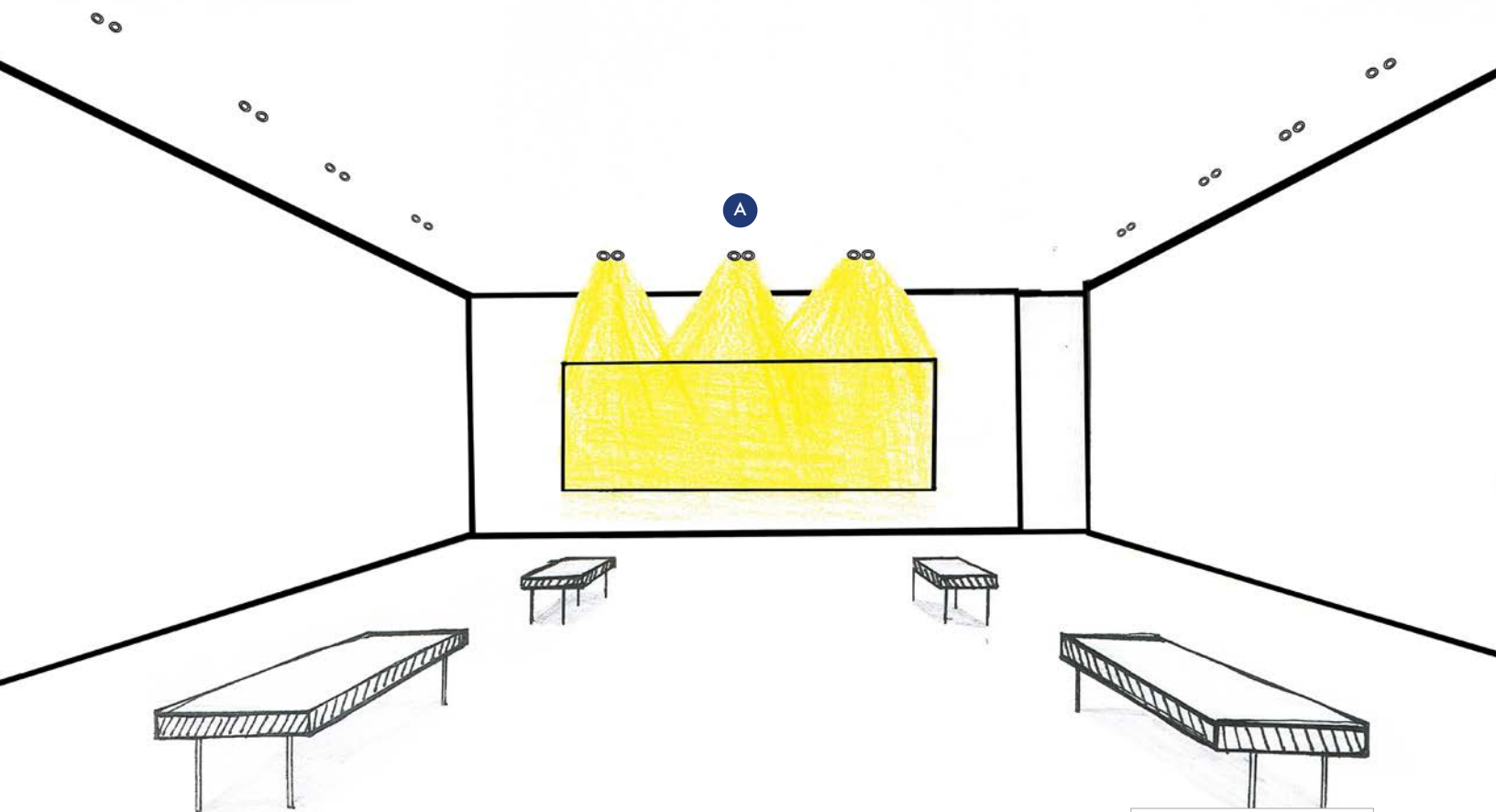

**KEY**

**A** Double Adjustable Round, 50°

**ROOM DIMENSION:** 20'W X 20'L X 9'H

**FIXTURE WALL OFFSET:** 2'-6"

**FIXTURE AIM ANGLE:** 30°

**NOTE:** Light level calculations reflectance values use standard 20% for floors, 50% for walls, and 80% for ceilings.

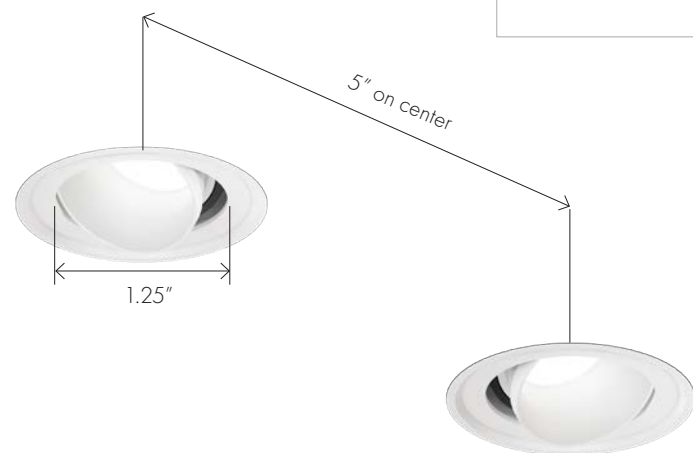

# Evenly Light Large Wall Art

The aiming diagram below demonstrates that a simple 30° tilt angle and mild rotation for light overlap with neighboring beams results in a smooth, even distribution of light on a large piece as below.

**A** DIRECT AIMING : ELEVATION

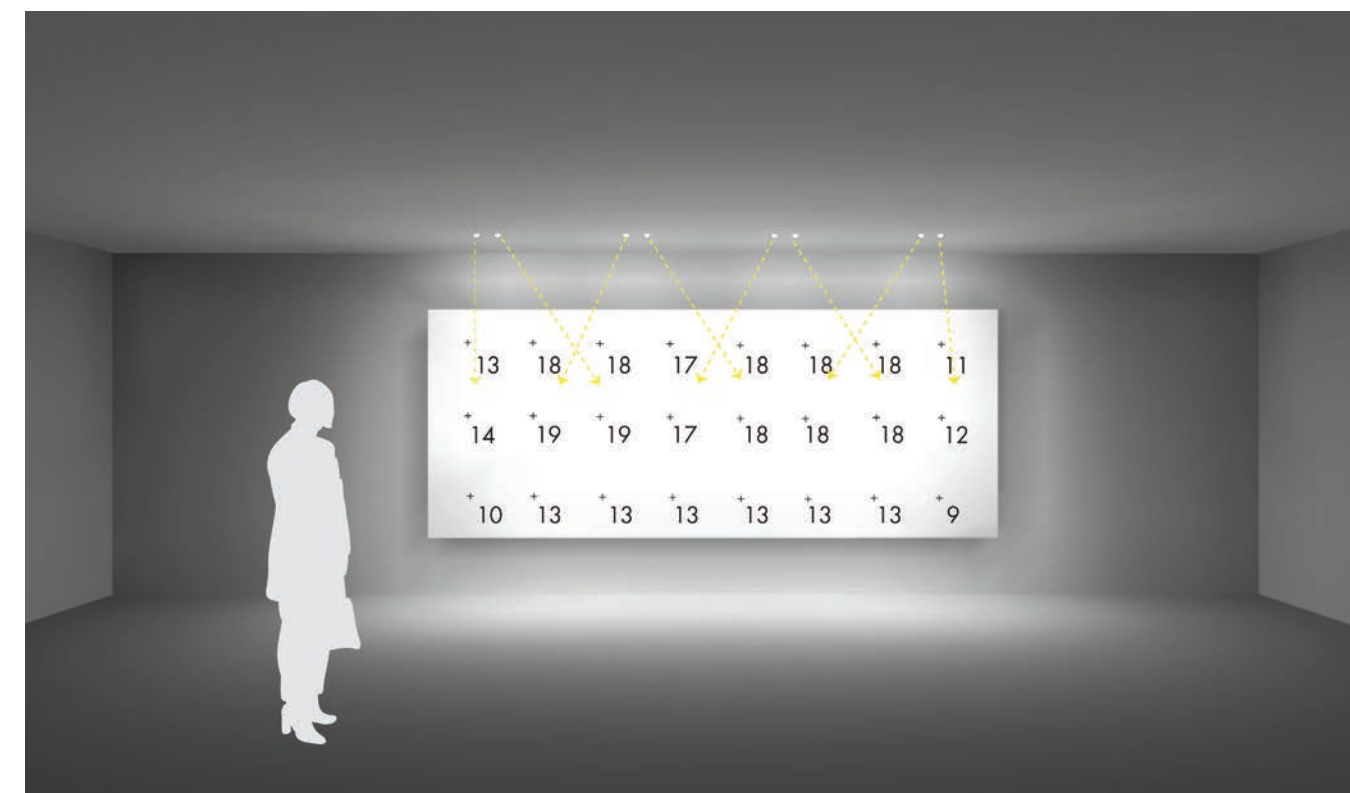

## LIGHTING INTENSITY

Avg On Artwork: 15 FC  
Max/Min On Artwork: 1.7

## SECTION

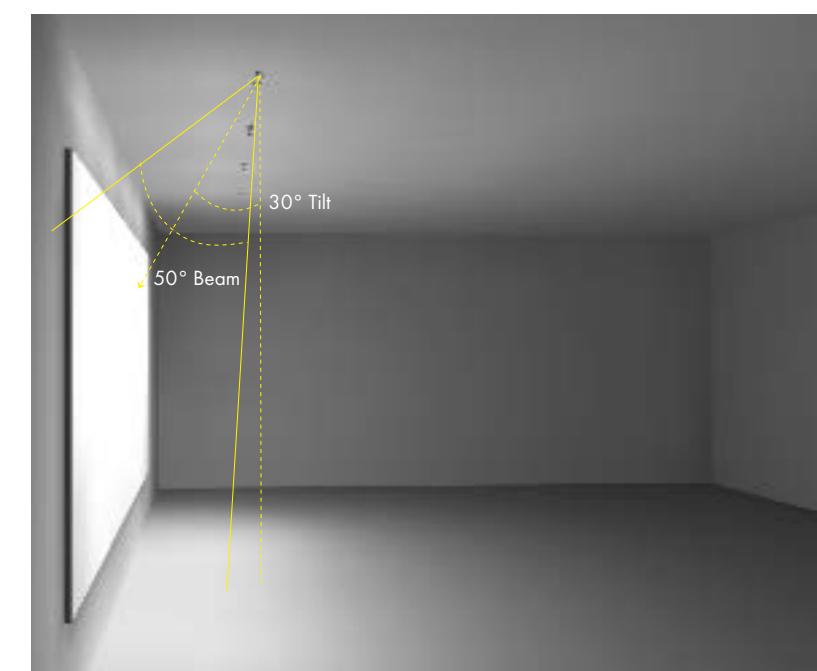



# LIGHT FOR SMALL & MEDIUM ARTWORK

In permanent installations, a regular light fixture spacing is usually desired even though the objects shown within the space may be on rotation and be placed in a variety of locations. Depending on the size of the artwork and spacing on the wall, you can use the **LittleOnes Micro Doubles Adjustable** fixture to aim directly at the piece or by using adjacent fixtures to cross-aim for better coverage.

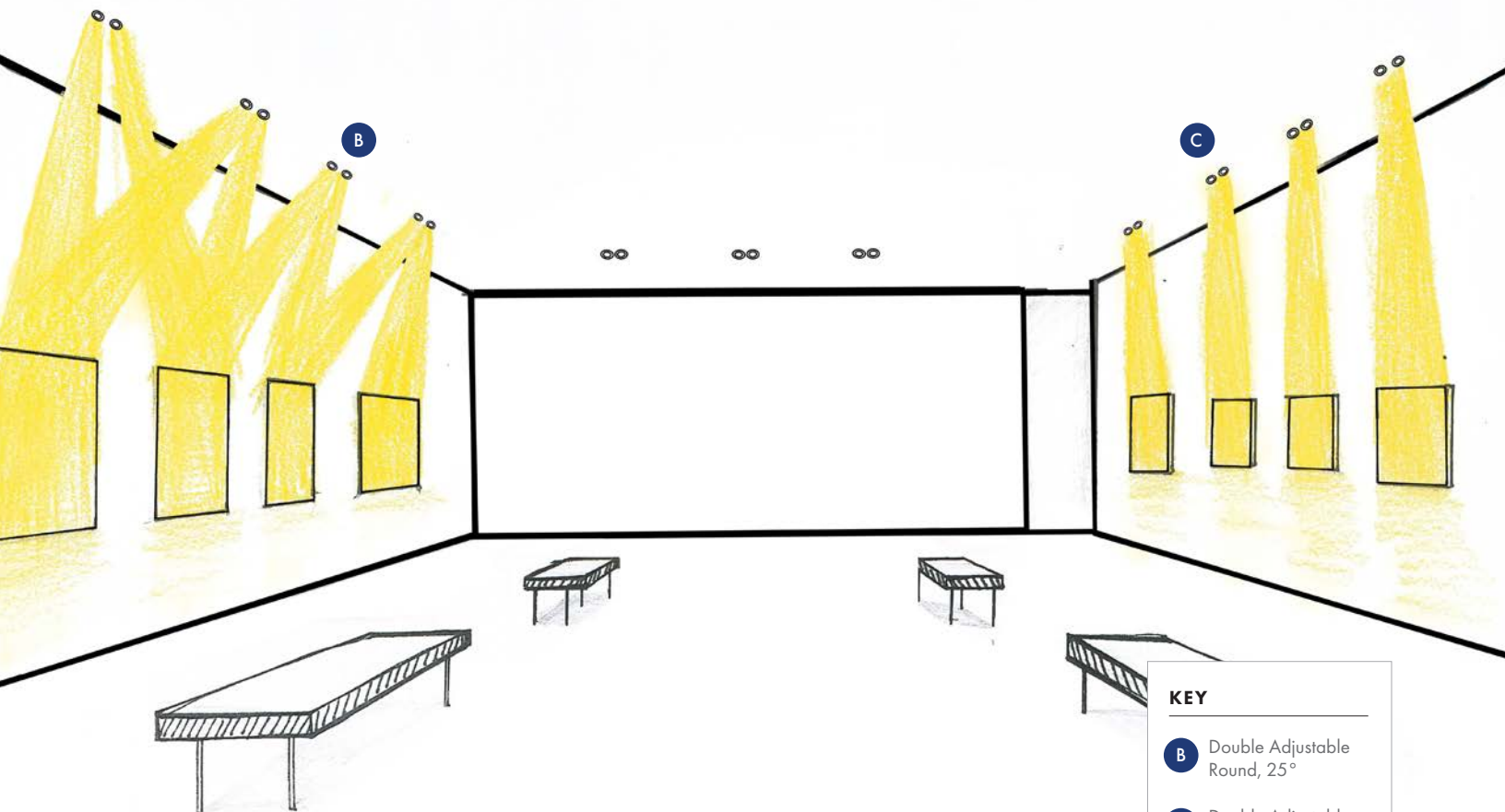

ROOM DIMENSION: 20'W X 20'L X 9'H

FIXTURE WALL OFFSET: 2'-6"

FIXTURE AIM ANGLE: 30°

**NOTE:** Light level calculations reflectance values use standard 20% for floors, 50% for walls, and 80% for ceilings.

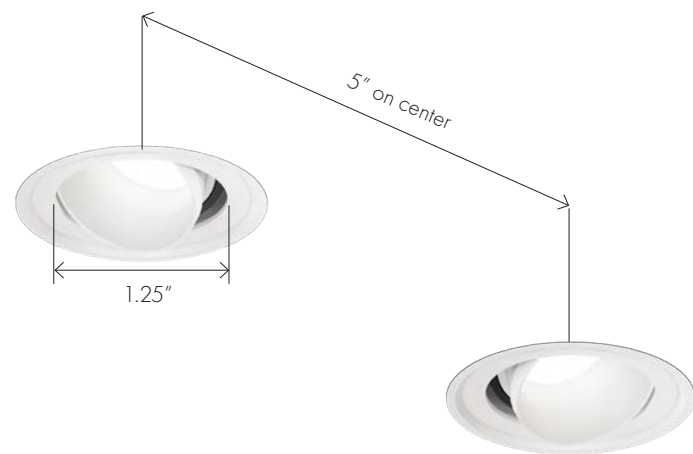

# Aiming and Cross-Aiming Light for Art

Direct aiming and cross-aiming are two different adjustable lighting techniques that can help solve practical problems in art installations. Our aiming studies shown here provide more details on the differences between these two lighting design approaches.

## B DIRECT AIMING : ELEVATION



## SECTION

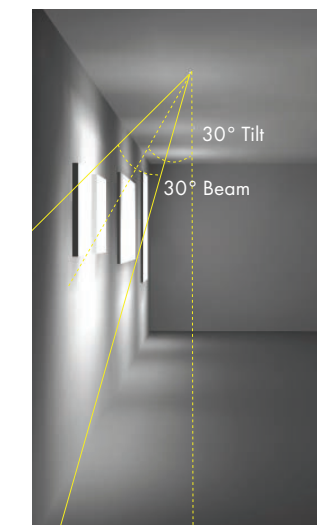

### ↑ LIGHTING INTENSITY

Avg On Artwork Left: 33.5 FC  
Avg/Min On Artwork Left: 1

Avg On Artwork Middle: 28.6 FC  
Avg/Min On Artwork Middle: 1.5

Avg On Artwork Right: 36 FC  
Avg/Min On Artwork Right: 1.6

## C CROSS AIMING: ELEVATION

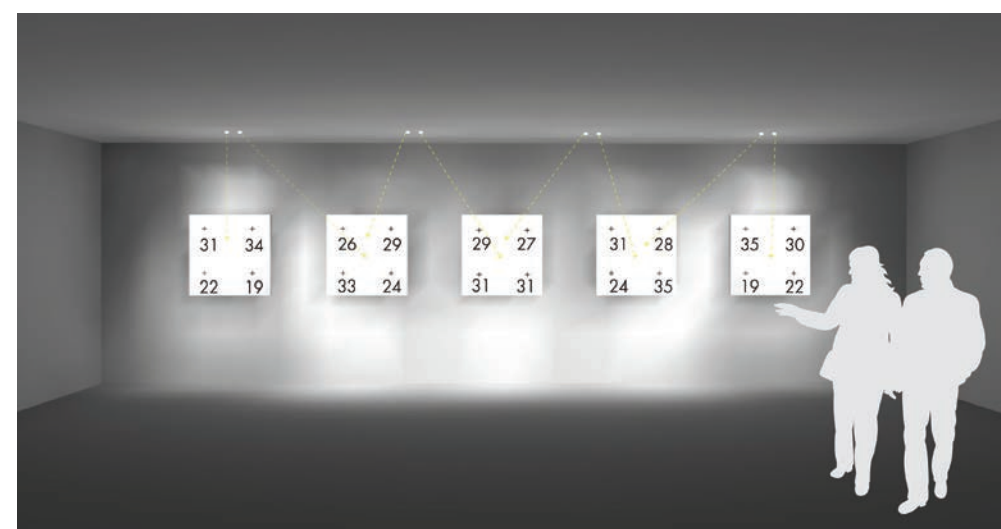

## SECTION

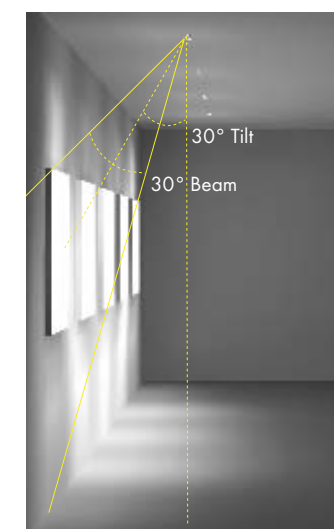

### ↑ LIGHTING INTENSITY

Avg On Artwork: 28 FC  
Max/Min On Artwork: 1.34

# LIGHT FOR MULTI-HEIGHT SPACES

USAI's broad range of light fixtures in **the LittleOnes family** can help you accomplish a holistic design with multiple layers of light. In the multi-height living space depicted here, the main space with double height ceilings are lit with **BeveLED Mini**, our high performing 3" aperture bevel series. These provide an excellent match with **the LittleOnes Micro and the LittleOnes Micro Doubles** round light fixtures. The Doubles adjustable fixture is used to highlight the main feature wall, providing a sense of brightness to the space even if actual light levels are dimmed and will also help focus attention on a favorite piece. **The LittleOnes Micro Doubles** downlight fixture is used elsewhere in the room to provide ambient illumination in the lower ceiling height spaces.



**KEY**

- A** BeveLED Mini Downlight Round
- B** Double Downlight Round
- C** Double Adjustable Round

## Combine Multiple USAI Product Families in Your Next Project

A consistent below ceiling aesthetic is critical to creating an intentional, uncluttered lighting design. **The LittleOnes Micro Doubles** pair wonderfully with our LittleOnes Micro singles and our BeveLED Mini series.

### LAYER A SPECIFICATION:

BeveLED Mini® Complete - Round Downlight



FIXTURE SPEC: B3RDL-20WG2-3022KH-65-S-WH

BEAM ANGLE: 65°

WATTAGE: 20W

COLOR TEMPERATURE: 3000K-2200K, 90+ CRI

DELIVERED LIGHT: 1325 lumen

GLARE (URG): 21.2



### LAYER B SPECIFICATION:

the LittleOnes Micro Doubles Round Downlight



FIXTURE SPEC: 2x M1RDL-07DW2-3020KH-50-M0-WH

BEAM ANGLE: 50°

WATTAGE: 14W

COLOR TEMPERATURE: 3000K-2000K, 90+ CRI

DELIVERED LIGHT: 700 lumen

GLARE (URG): 26.6

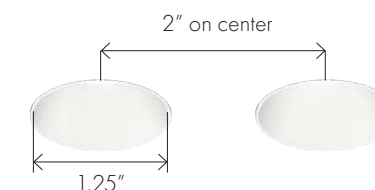

### LAYER C SPECIFICATION:

the LittleOnes Micro Doubles Round Adjustable



FIXTURE SPEC: 2x M1RAL-07DW2-3020KH-35-M0-WH

BEAM ANGLE: 35°

WATTAGE: 14W

COLOR TEMPERATURE: 3000K-2000K, 90+ CRI

DELIVERED LIGHT: 650 lumen

GLARE (URG): 19.2

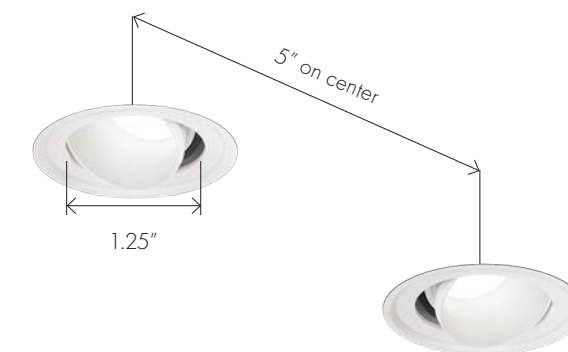

# the LittleOnes<sup>®</sup> Micro Doubles Optics

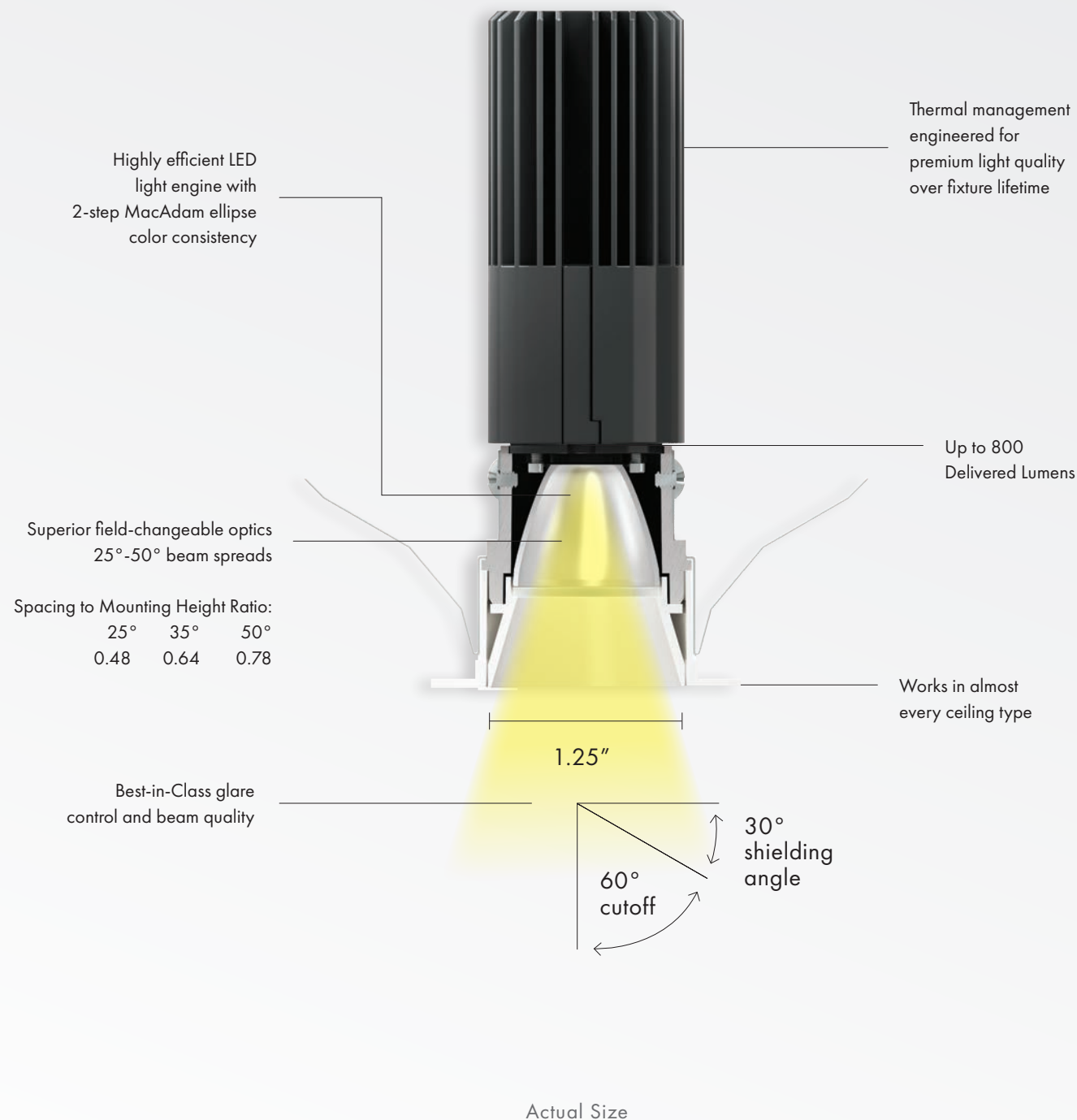

## LED Color Choices

### CLASSIC WHITE

LED is available in a variety of color temperatures, from warm to cool, in 80+ or 90+ CRI

Varying color temperatures for light influence how we look, feel and see in a space.

Lighting can cater to our needs for each activity enhancing the experience and matching the mood we want to create.



### DIM-TO-WARM

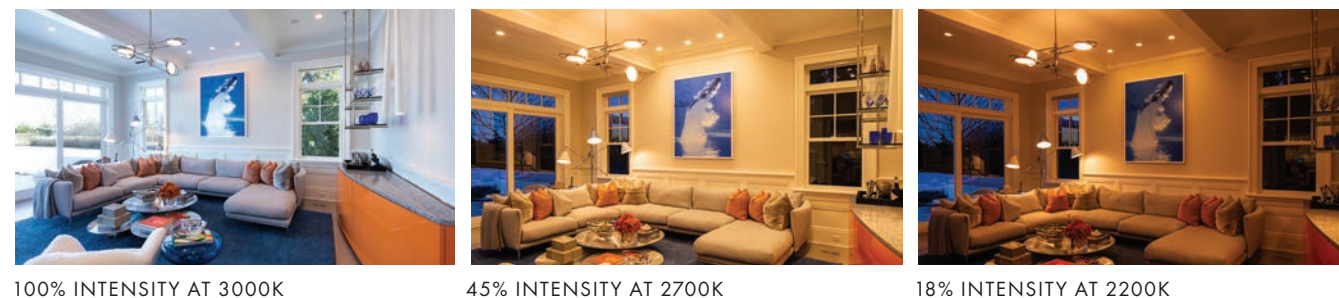

DIM-TO-WARM PERFORMANCE CURVE

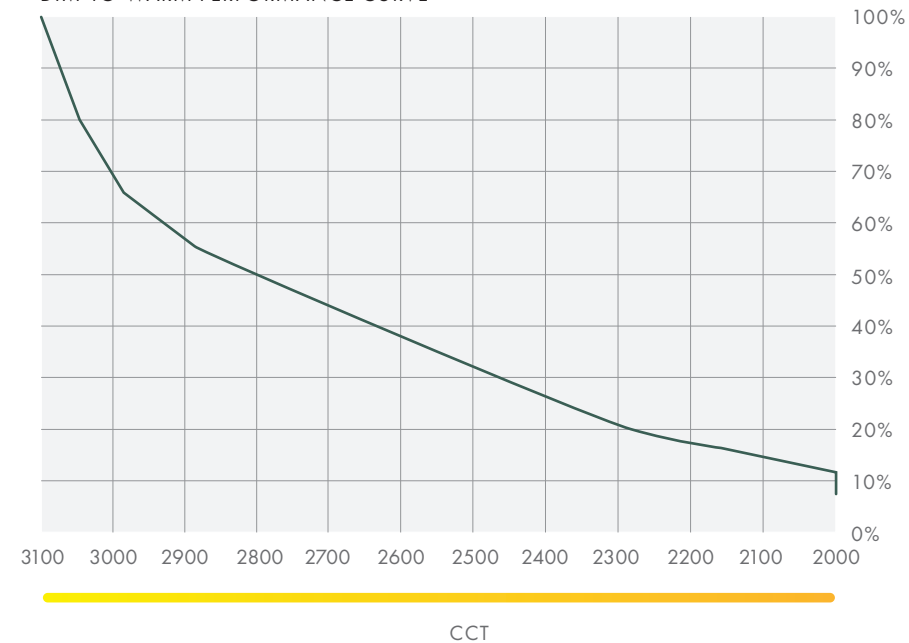

LEDs shift to a warm 2000K as you dim. Warmer color temperatures add warmth and enrich colors with depth, bringing intimacy and sophistication to a space, all in 90+ CRI.

# the LittleOnes<sup>®</sup> Micro Doubles

## SERVICEABLE AFTER INSTALLATION



### NC REMOTE DRIVER HOUSING

Install From Above. Service From Below For Optic & Light Engine Only, Driver Is Remote.

#### TRIMMED

Trimmed fixtures compatible with sheetrock, ACT, wood/millwork, and many other ceiling materials

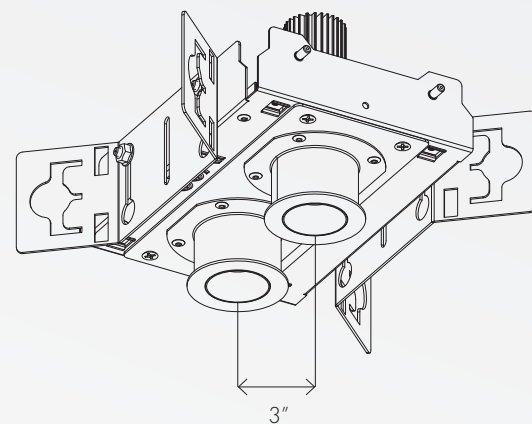

Downlight / Wall Wash

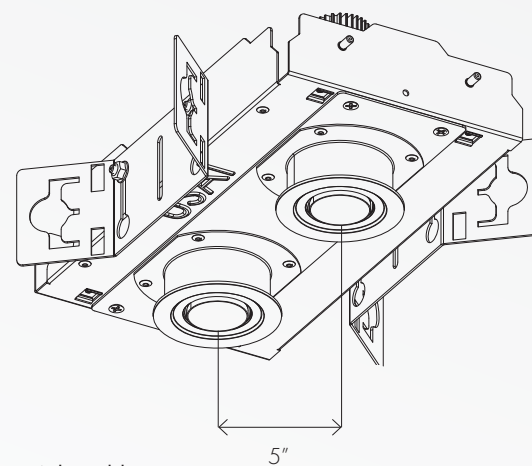

Adjustable

#### TRIMLESS

Use With Sheetrock and Plaster Only

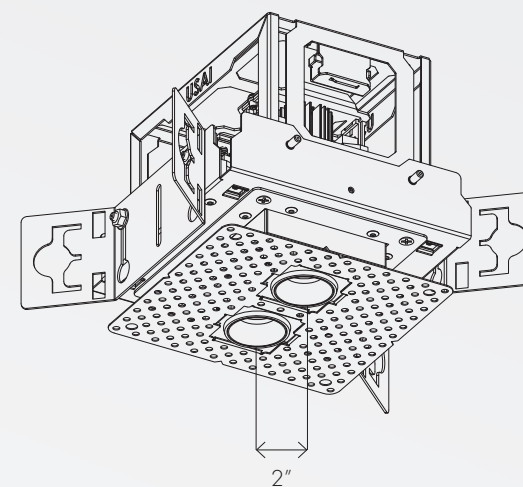

Downlight / Wall Wash

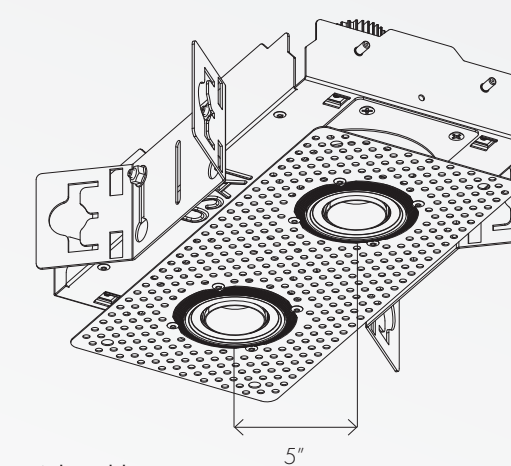

Adjustable

### NEW CONSTRUCTION SIDECAR HOUSING (NCSC)

\*Above Ceiling Access Required For All Integral Driver Housing Installations

Install From Above. Service From Above.

#### TRIMMED

Use With All Materials

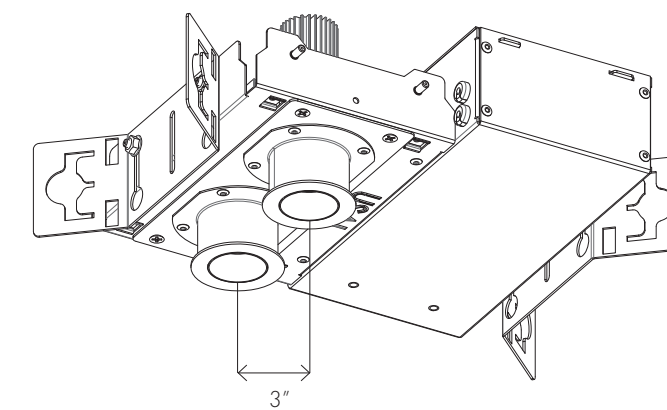

Downlight / Wall Wash

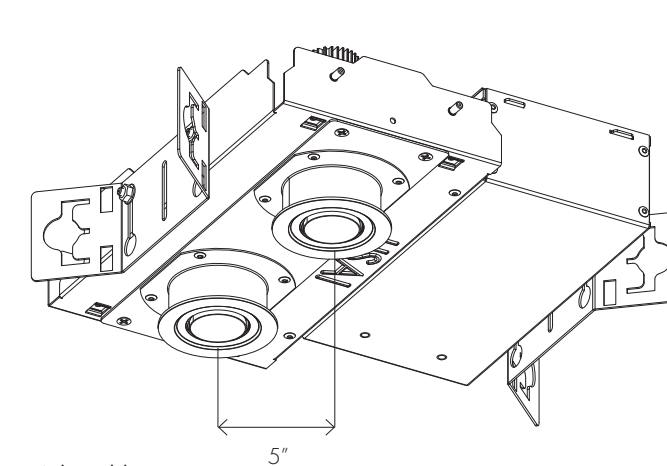

Adjustable

# POWERING THE DOUBLES

USAI's the LittleOnes Micro Doubles are compatible with all common lighting controls; choose from 0-10V, Phase, EcoSystem, DMX, or DALI dimming

## 2 WAYS TO WORK WITH REMOTE DIMMING DRIVERS

### 1 Standard Output with Remote Driver

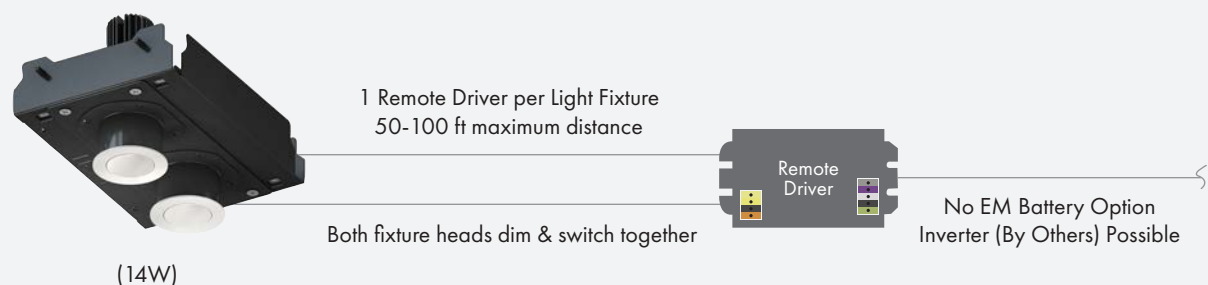

### 2 High Output with Remote Drivers

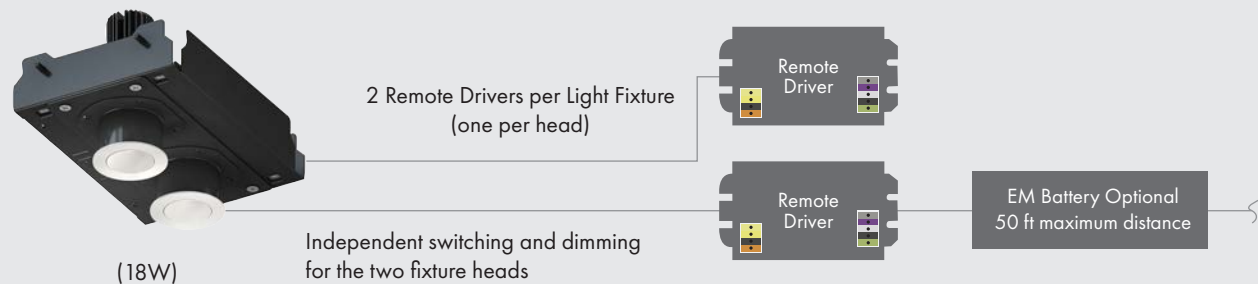

## Integral Dimming Option

One integral dimming driver per light fixture. Both fixture heads dim and switch together. Above ceiling access required for service to the driver. Available with trimmed fixtures only.

No EM Battery Option Inverter (By Others) Possible



## Optional USAI Enclosures

All remote drivers require enclosures by code. We make your specification process easier by offering different driver enclosures to fulfill all of your project needs, as shown below.

### Single Driver Enclosure Options

For one remote driver at a time only.



ENC Single Driver Enclosure



MP Junction Box mounting plate enclosure

### 6-Driver Prewired

Enclosure houses up to 6 dimming drivers.

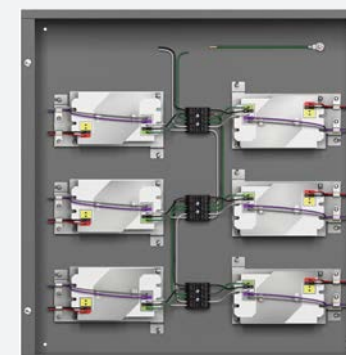

### 12-Driver Prewired

Enclosure houses up to 12 dimming drivers



### Did You Know?

USAI offers applications assistance for configuration of remote drivers and remote driver enclosures. Contact your local USAI representative for additional driver layouts and different power requirements, or for custom configurations.

# KEEPING IT IN THE USAI FAMILY

USAI offers a wide range of light fixtures from tiny to small while maintaining a consistent below ceiling aesthetic. Mix and match from several product ranges on your project with confidence that the end result will appear polished and well-planned out.

## SMALL RECESSED DOWNLIGHTS



LittleOnes® Zepto®  
1"



LittleOnes® Micro  
1.25"



Micro Multi-Cell  
1.25" cells



SliverLED®  
1.75"



BeveLED Mini®  
3"

## SMALL SURFACE MOUNTED + PENDANTS



Micro Multi-Cell Pendant  
1.25" cells



NanoLED® Glow Cylinder  
3"



NanoLED® Cylinder  
3"



BeveLED Mini® Cylinder  
3.5"

# FAQs

**Q: Do the LittleOnes always require remote drivers? Where is the ideal location for remote drivers and how far away can I position them?**

**A:** Due to the LittleOnes' minuscule size and tiny 1" apertures, it is not possible to access dimming drivers for service from below the ceiling. All of the LittleOnes are available with remote drivers which can easily be accessed in service panels or electrical closets, and they can be located up to 100 ft away depending on wire gauge used. We do have one housing option that can house an integral driver, but this fixture would require above ceiling access to remove that driver from the housing for service.

**Q: Which control systems are compatible with the LittleOnes?**

**A:** As with all USAI Lighting products, the LittleOnes are compatible with every major architectural control system you could choose to use, including 0 - 10V low voltage dimming, line voltage phase dimming, and digital dimming protocols such as DMX and DALI.

**Q: How well will the LittleOnes light my walls? How close do they need to be?**

**A:** Despite their tiny size, the LittleOnes are outstanding in wall wash applications, providing perfect uniformity from floor to ceiling. For best results, we recommend placing them 24" from the wall and no more than 18" apart from each other.

**Q: Can I place the LittleOnes in wet locations such as showers and outdoor covered spaces?**

**A:** Yes! All of the LittleOnes are UL dry/damp/wet location rated.

**Q: Can I service the LittleOnes LED and optics from below?**

**A:** Yes! If a change is desired in LED color or optics and beam spread, you may need to access internal components in the rare event that service is needed. USAI's engineering has made this access easy and painless.

**Q: How far apart can I space the LittleOnes and still light evenly?**

**A:** Even though they're only 1" in size, we have found that the LittleOnes can be placed up to 4', 5', and 6' apart while still delivering useful light and great uniformity. If you're not sure, you can always contact USAI for help with applications calculations for your project.

**Q: What is the maximum ceiling height recommended for the LittleOnes?**

**A:** The answer to this question depends on how much light you need, and how closely you are placing the LittleOnes to each other. We have found that the LittleOnes can provide beautiful illumination in 8', 10', and 12' ceilings. When ceiling heights get to 14' and higher, consider using other USAI products with larger apertures and more light output; we offer a full family of companion products for the LittleOnes with similar trim aesthetics - so they look great together.

**Q: How do I use the LittleOnes as emergency fixtures?**

**A:** The LittleOnes can be specified with a remote emergency power module. Simply use the One Fixture per Driver ordering tables to specify the LittleOnes light fixture of your choice, and then specify a remote dimming driver with the EM option. All remote dimming drivers with the EM option require a remote enclosure. Two or more fixture per driver options can be used as emergency fixtures with the use of inverters. See spec sheets for details.

**Q: In what ceiling types do the LittleOnes work?**

**A:** The LittleOnes family works in almost every type of ceiling imaginable, including but not limited to: sheetrock, plaster, wood, tile, acoustical tiles, metal panels, and more.



the LittleOnes<sup>®</sup> Micro Doubles  
TWICE THE POWER

**USAI**<sup>®</sup>  
Lighting

CALL, EMAIL, OR VISIT [USAILIGHTING.COM](https://www.usailighting.com) TO LEARN MORE

**USAI LIGHTING COLLABORATORY**  
13 CROSBY STREET  
NEW YORK, NY 10013  
(845) 234-4090  
[SHOWROOM@USAILIGHTING.COM](mailto:SHOWROOM@USAILIGHTING.COM)

**USAI LIGHTING HEADQUARTERS**  
1126 RIVER ROAD  
NEW WINDSOR, NY 12553  
(845) 565-8500  
[INFO@USAILIGHTING.COM](mailto:INFO@USAILIGHTING.COM)

©2023 USAI, LLC. All rights reserved.  
USAI, BeveLED, BeveLED Mini, Classic White,  
Warm Glow, the LittleOnes, NanoLED,  
Zepto and SliverLED are registered trademarks of  
USAI LLC. All designs protected by copyright.  
Covered by US Patents. Patents pending CA-145B